

twogether

Paper Technology Journal



PROCESS & PROGRESS

Mapping the Future.

News from the Divisions:

Low intensity refining.

Dagang – successful startup of an unprecedented project.

Procart – Latin America's most advanced board machine.

Janus MK 2 – fruit of more than 20 Janus calendars.

Paper Culture:

200 years of paper machines.

8

Contents

EDITORIAL

Foreword	1
PROCESS & PROGRESS – Mapping the Future	2

NEWS FROM THE DIVISIONS

Stock Preparation Division: Low intensity refining of hardwood and deinked pulps with a new generation of filling	7
Stock Preparation Division: “Pick-up-Method” confirmed as TAPPI Test Method – a new process for stickies measurement	12
Paper Machinery Divisions: Dagang – successful startup of an unprecedented project	14
Paper Machinery Divisions: Soporcel 2 – Europe’s largest capacity fine paper machine	18
Paper Machinery Divisions: CPI Biron PM 25 rebuild – a success story	21
Paper Machinery Divisions: MasterJet F/B – the great little headbox for demanding needs	24
Paper Machinery Divisions: From minutes to seconds – new perspectives in paper quality	26
Paper Machinery Divisions: Procart – Latin America’s most advanced board machine	31
Paper Machinery Divisions: S.A.I.C.A. – the worldwide fastest paper machine for corrugated medium	34
Paper Machinery Divisions: Rizhao – another complete board production plant for China to strengthen market leadership	36
Finishing Division: Janus MK 2 – fruit of more than 20 Janus calendars	37
Finishing Division: Twister goes American – innovative roll wrapping in practice	42

RESEARCH AND DEVELOPMENT

How to prevent tiger stripes	47
The significance of response function width and mapping quality for control system performance	48

CORPORATE NEWS

Voith Sulzer Paper Technology and Fibron – together and proud of it!	50
Concentrated deinking know-how	55
Revolutionary new technology for tissue making	58

PAPER CULTURE

200 years of paper machines – Voith and Sulzer were in from the very beginning	62
--	----

Frontispiece

The Paper Machinery Division Graphic held a customer symposium in March this year entitled “Process & Progress”. At the end of the first day, a “Dream Wedding in Paper” was presented by the Berlin School of Fashion Design — symbolizing the marriage of paper with technology (see “Mapping the Future” on page 3).



Hans Müller,
President and CEO
Voith Sulzer Paper Technology

Dear Customer, dear Reader,

As we approach the new Millennium, I believe a number of interesting pulp and paper milestones are worth mentioning.

At the beginning of our calendar system in the year 105 A.D., TSAI LUN, a Chinese, invented a process for making the prototype of paper as we know it today. He mixed plant fibers with other materials to make a sheet-like structure that could be written on. Almost two Millenniums later, and again in China, the world's two largest fine paper machines started up operations in Dagang, Jiangsu Province. Both built by Voith Sulzer Paper Technology with a wire width of 10.5 m, the machines came on stream at the beginning of 1999 and have reached operating speeds of 1,350 m/min and a joint production of up to 3,000 tons of paper per day.

The current year is also the 200th birthday of the invention of the first continuous process for manufacturing paper. Nicolas Louis Robert developed this great idea in 1799 and we feature the event at the end of this issue.

Shortly afterwards, the forerunner companies of Voith Sulzer Paper Technology took up the industrial development of the process and today we are building machines which will lead the industry into the next Millennium.

The Voith Sulzer Paper Technology team is proud to have maintained its leading position in the supply of machines and processes serving the pulp and paper industry. Of the new production units starting up worldwide in 1999 and 2000, 38% of the capacity is on Voith Sulzer machines (status May 1999). This represents the strongest performance among the major machine suppliers.

We hope you will find this „twogether“ issue No 8 as interesting as the previous ones!

Yours sincerely,

A handwritten signature in blue ink that reads "Hans Müller". The signature is fluid and cursive, written in a professional style.

Hans Müller
on behalf of the Voith Sulzer Paper Technology Team

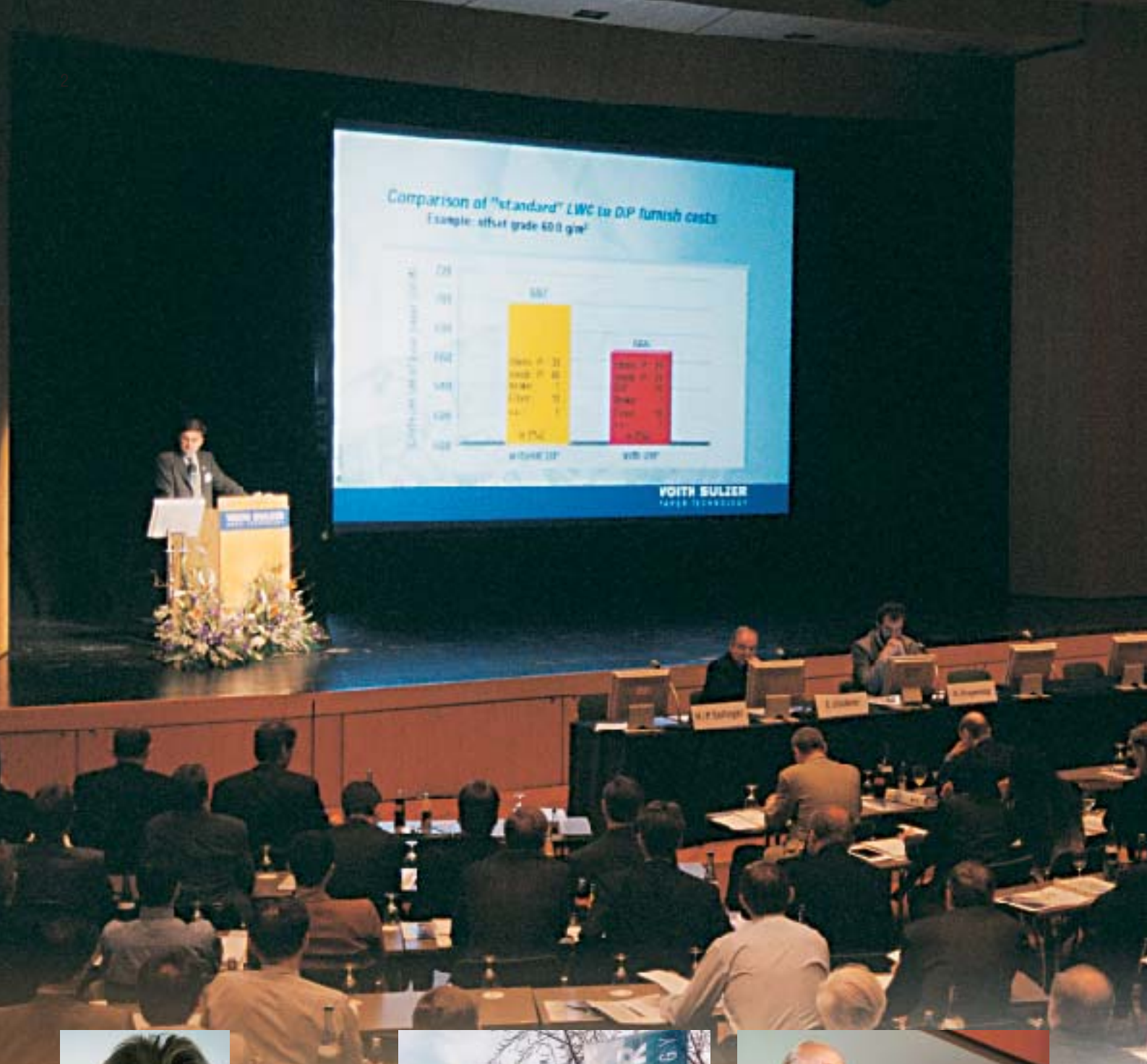

The author:
Marion Nager,
Corporate Marketing



Mapping the Future

Nearly everyone responded to the Graphic Paper Machinery Division's invitation last March. More than 30 countries, from Chile to China, were represented by 420 top managers at our customer seminar in Ulm and Heidenheim. This international gathering of decision-makers and experts from the paper industry, leading institutions and universities was also well attended by the press. Which shows the importance attached these days to well-founded answers to some fundamental questions:

- What is the future of the paper industry?
- In which direction will graphic paper markets develop?
- Which primary demands will paper-makers have to meet in future?
- What solutions does Voith Sulzer Paper Technology offer for meeting these demands?
- How can customers be sure of competitive advantages and a fast return on investment?

Guests were warmly welcomed by Hans Müller (left), President and CEO Voith Sulzer Paper Technology. He underlined VSPT's outstanding market position by quoting orders on hand worldwide – including nine complete graphic paper lines, eight board and packaging paper machines, and three tissue machines. An attentive international audience from science and industry followed all papers with genuine interest.





A festive address by Hans-Peter Sollinger, Managing Director Voith Sulzer Papiermaschinen GmbH & Co. KG, Heidenheim. He explained what circus acrobatics and paper artworks mean in terms of meeting last-minute customer requirements – and reaped an ovation of approval.



Although the classical print media still hold the lead in global communications, our electronic age is catching up to them. Television, Internet and headlong progress in computer technology are opening up new possibilities. How can we stay in front despite this enormous challenge? How can we win the battle fought every day among newspapers and magazines for reader circulation? Above all, how can the paper industry meet ever-increasing quality demands for brilliance of printing, colour and graphical reproduction?

Guest speakers from internationally reputed market research institutions and the printing machines industry outlined future trends and product demands on graphic paper manufacturers.

Manfred Tiefengruber, manager of production line 4 at Sappi Europe, Gratkorn, Austria, explained how these demands can be met successfully in partnership with Voith Sulzer Paper Technology. As an example he quoted the joint realized ***Triple Star*** project, currently the world's largest capacity production line for high grade graphic papers.

A dozen speakers representing technology, research and development on both sides of the Atlantic presented results showing the latest state of Voith Sulzer Paper Technology developments for cur-

rent and future needs. Particularly clear was that while individual component improvements bring technical benefits and cost savings, only their systematic integration over the production process – from stock preparation to finishing – as a whole gives customers real competitive advantages, usually online.

So the logo of this customer symposium – Process & Progress linked by a paper web – was apt indeed. Comprehensive



The Heidenheim tour gave guests an interesting insight into Voith Sulzer Paper Technology Research & Development and production – an impressive illustration of customer partnership potential.



system efficiency is undoubtedly the key to product and market success in future, through progress in process technology.

Mapping the future: an ambitious goal likewise for the team and helpers who prepared this symposium. Not only their work was put to the test at the fully booked Ulm symposium, but also Voith Sulzer Paper Technology's competence and partnership in technological leadership. All these efforts were clearly crowned with success: despite an extremely intensive programme, even the last speaker still claimed the enthusiastic attention of his audience. To sum up the comments heard afterwards – the journey had been well worthwhile.

Worthwhile also in another way: for relaxation, entertainment and sheer enjoyment. That evening after dinner, the day was rounded off under the star-spangled dome of a circus tent, lavishly decorated with artworks and fashion designs all of paper. Just to show that paper is not only a printing medium, but has other attractions as well...

While the first day of this symposium had been devoted to a theoretical look at the future, the second day was devoted to practical revelations: a tour of the Heidenheim R&D centre and workshops. This brought our guests face to face with state-of-the-art process developments and production implementation.

Heidenheim is the nerve centre of Voith Sulzer Paper Technology's worldwide R&D activities. It is also an important centre for customer support and production optimization trials, where all test results are precisely documented. The possibilities thus opened up for practice-oriented customer partnership were impressively demonstrated on our paper machine testbed, two coating machine facilities, the Sirius winding test facility and a wide variety of peripheral equipment.

Guests were fascinated in the production shops by two tandem NipcoFlex presses for newsprint and SC paper machines – world record candidates yet again – under final assembly prior to delivery. Among many other innovations and further developments were also some impressive products of Voith Sulzer's new US and Canadian subsidiaries Impact and Fibron.

"A highly successful symposium and a most enjoyable rendezvous, underlining your outstanding expertise and upholding our cooperation." This kind of praise from paper industry leaders is certainly good to hear after such events. It redoubles our enthusiasm and our commitment to customer partnership.

And since all good things should be repeated, the next symposium is already scheduled.



Stock Preparation Division:

Low intensity refining of hardwood and deinked pulps with a new generation of filling



*The author:
Ronald Sigl,
Stock Preparation Division*

Refining plays an important role in stock preparation as well as throughout the complete paper making process. Next to raw material selection, it has the greatest influence on final product quality. This high ranking in the process makes it all the more important to operate with the optimum refiner, equipped with the optimum type of fillings and under optimum refining parameters.

This paper describes the refining of several hardwood pulps (eucalyptus, birch and mixed tropical hardwood MTH) as well as recovered fibres (DIP), using a new generation of fillings. The new type has a finer bar width and narrower

grooves, resulting in increased cutting edge length (CEL).

To meet growing demands for low intensity refining, the new plate design secures a reduction in specific edge load (SEL) and no-load power, enabling operation under low intensity conditions. Resultant benefits for the papermaker are higher refiner efficiency and lower total specific refining energy as well as better paper quality.

Why low intensity refining?

Raw material market surveys show that in the future the demand for paper and board will increase. The biggest increase

will be in recovered fibre stock, while virgin pulp will increasingly originate from short-fibered hardwoods, particularly fast-growing species from plantation areas in Asia. Industrial requirements are responsible for this development. It is a fact that more and more short-fibre hardwood pulps are being used, not only due to their excellent optical properties (good opacity) and improved surface characteristics (good printability) but also due to their low costs. With this increasing use of hardwood pulps, the importance of refining similarly increases. Today, these pulps can secure high strength properties, but the papermaker needs to reach the best possible overall result with the furnish. Thanks to the high strength properties of hardwood pulps, the proportion of softwood pulps in paper products can be reduced. For optimum results with this type of furnish, refining conditions have to be modified.

Hardwood pulps have shorter and thinner fibres than softwood pulps, and their resistance against refining load is much lower. Likewise, secondary furnishes have a relatively low refining resistance, since most of the fibres have been refined previously. For this reason, refining of hardwood and secondary furnishes should be very gentle, requiring low intensity refining with a low specific edge load. Energy input should be very low. This optimally exploits the papermaking potential of the fibres, primarily by mini-

mizing, or even avoiding any further shortening of fibres.

What does low intensity refining mean?

The technological results and cost of refining depend on the intensity and frequency of the fibre treatment. Fibre treatment conditions are best described by the key figure "specific refining energy", which indicates the refining energy needed per ton of fibres to reach the required result. It is the quotient of net/total power and mass flow of stock. It can be understood as the product of intensity and frequency of fibre treatment. However, specific refining energy is not adequate for exact description of the refining process or prediction of refining results. For this reason, several other key figures were worked out describing intensity and frequency of fibre treatment.

A globally acknowledged measure of refining intensity is specific edge load SEL as defined by Brecht and Siewert. It is calculated from the net refining power and the cutting edge length CEL. The net refining power is the difference between total refining power and pumping power (no-load or idling power in water) and the CEL is the product of the number of rotor and stator bars, the bar length and rotational speed.

The higher the SEL, the more fibres are cut and shortened, while a lower value has a more pronounced fibrillation effect.

For refining under low intensity conditions, there are two possibilities:

- Reduce refining power.
- Increase cutting edge length.

Reducing refining power results in poor efficiency, with the result that more machines are required for attaining a given result. To increase CEL, more bar length is required, and therefore finer bar widths and/or narrower grooves are necessary.

Requirements for a new generation of fillings suitable for low intensity refining

The bar and groove width should be as fine as possible. Due to material strength considerations and to avoid excessive fibre shortening, the bar width can only be reduced to a limited extent. Material strength is also affected by bar height, since the lower the height, the finer the bars can be. Another advantage of a low bar height is a low no-load power.

On the other hand, the bar height must be sufficient to secure the required throughput and an adequate service life. The latter factor is particularly important since secondary raw materials are generally more abrasive than primary fibre stocks due to their high filler content. In order to avoid the risk of plugging, the groove width should not be reduced beyond a certain minimum limit.

Fig. 1: The Voith Sulzer TwinFlo E refiner.

Fig. 2: Cross section through the TwinFlo E refiner.

Fig. 3: The refining plant and specific trial conditions in the Voith Sulzer Stock Preparation Research and Technology Centre.
 Refiner: industrial size. Refining at 4-5 % consistency. Charge per trial 250 kg o.d..
 Flow 360-2100 l/min. Changeover chest refining.
 For slushing: fresh water, 30-35 °C.

In all cases, the CEL must be as high as possible in order to keep the ratio of no-load power to total refining power as low as possible at relatively low specific edge loads, thus improving refining efficiency.

Trial conditions

Extensive trials with different types of fillings (bar and groove width, cutting angle) and specific edge loads were carried out in the Research and Technology Centre of Voith Sulzer Stock Preparation. The aim of the trials was to find the optimum parameters for obtaining best technological results with various furnishes. The results presented here summarize the main findings. Fig. 3 shows the refining plant and test conditions.

The double disk refiner TwinFlo E

Fig. 1 and 2 show the new Voith Sulzer TwinFlo E double disk refiner. Five different sizes are available, each with up to four different fillings diameters. The installed motor power range is up to 3000 kW.

The stock flowing into the machine is distributed evenly between the two refining gaps. The rotor is hydraulically self-centering thanks to free axial movement on the spline shaft. This arrangement secures precision parallelism of the refiner fillings and provides a highly efficient and uniform fibre treatment. To adjust the refining gap, an electro-mechanical device moves the stator in the axial direction,

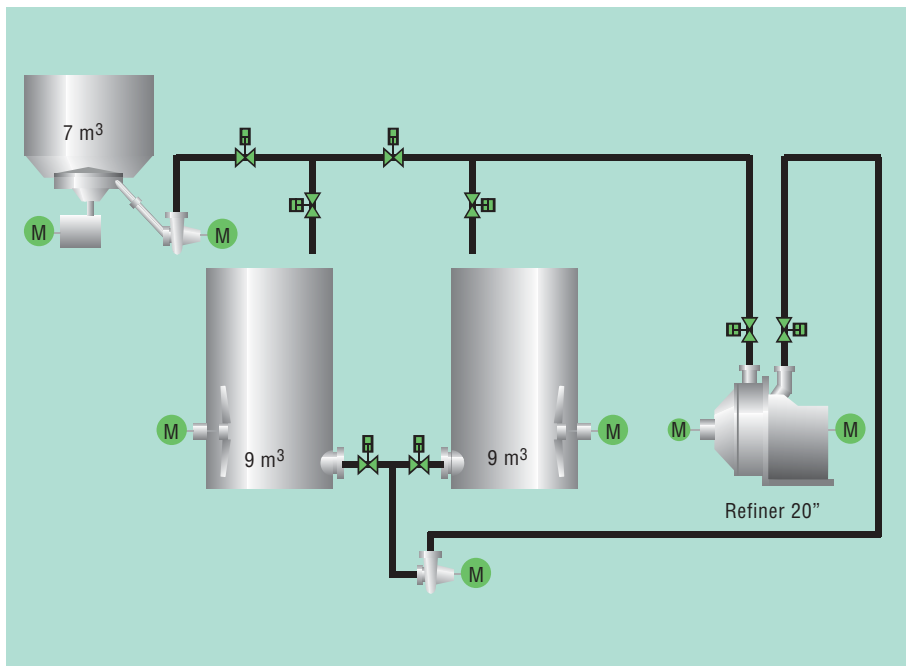
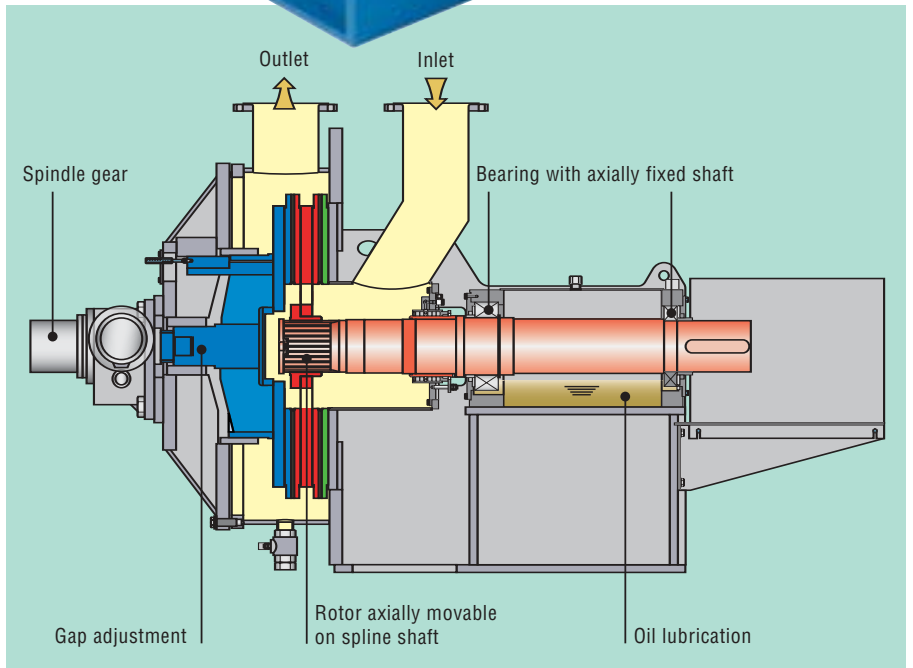
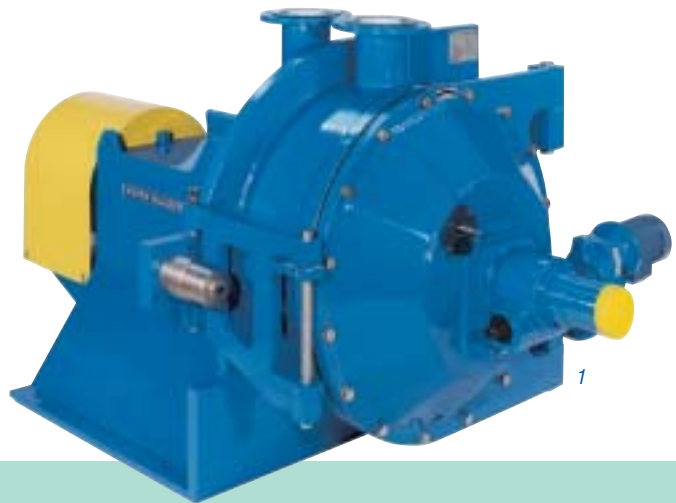

which also adjusts motor load. If stock flow fails, the electro-mechanical adjusting device provides a high speed release system. An integrated plate changing device ensures quick and easy exchange of fillings.

Results

Cutting angle

Eucalyptus/birch:

When refining these short fibres, better results are attained with a cutting angle of 40° rather than 60°. With birch, for example, a given tensile strength of 70 Nm/g is reached at a lower SR value (28 SR with 40° and 33 SR with 60°), and 14 % less refining energy (30 kWh/t) is needed (Fig. 4).

Mixed tropical hardwood MTH/

Deinked Pulp DIP:

The tensile strength characteristic for MTH and DIP indicates that contrary to experience with eucalyptus and birch, best results are achieved with a cutting angle of 60°. In addition, refining MTH and DIP stocks with a cutting angle of 60° is much more energy efficient.

Another important factor with hardwood pulps is their vessel cells. These cells are often the cause of offset printing defects, widely known as vessel picking. Vessel cells are very flat, flexible and about 0.5-1.0 mm long. Their flexibility makes the cells almost impossible to fractionate

and very difficult to reduce in size. During the printing process, there is a risk of the vessel cells being picked out and adhering to the surface of the press blanket, thus causing printing defects. There is, however, a possibility of reducing vessel picking. With suitable fillings the z-strength of the paper can be increased to such an extent, that the cells are held in the paper plane and no longer picked out. Refining with a cutting angle of 60° and up to 40-50 SR gives excellent results.

Bar width

The reduction in bar width from 3 to 2 mm leads to slightly lower tensile strengths. The cutting effect with finer bars is somewhat higher. With wider bars a significantly higher energy consumption is required to achieve a particular refining result, e.g. strength characteristics. Bar width influences tensile strength development much less than cutting angle. Fillings with 2 mm bars and 40° cutting angle result in higher strength properties, for example with eucalyptus or birch, than 3 mm/60° fillings.

Specific edge load

Eucalyptus/birch:

With lower refining intensity, the increase in tensile strength is greater (Fig. 5). The higher SEL of 1.2 J/m results in a slightly faster initial increase in tensile for birch, but after a certain point, however, there is virtually no further increase at all. This

standstill in tensile development is due to so-called overloading where the edge load limit is exceeded. Other strength properties react similarly. For eucalyptus, an SEL of 1.2 J/m is already too high at the beginning of refining and strength development is very much inferior. A low SEL is much more efficient.

Deinked pulp:

The lower the SEL, the higher the tensile strength attained (Fig. 6). In terms of specific energy, there is virtually no difference in tensile strength up to an energy consumption of 50 kWh/t. With further refining, however, the higher intensity leads to higher SR values, which means reduced dewatering on the paper machine and reduced production capacity. With higher intensity refining (1.5 J/m) the development in tensile as a function of total specific energy shows an overloading tendency. Refining with an SEL higher than 1.0 J/m is therefore uneconomic and leads to lower strength properties.

The same applies for the development in tear strength. The lowest possible SEL is the optimum setting. Here tear strength can be maintained during refining and drops only slightly at higher energy input, whereas at an SEL of 1.5 J/m, the tear value drops immediately. The advantage of high tear strength values is better runnability of the paper and printing machines.

Fig. 4: Influence of cutting angle on tensile strength for hardwood pulps.

Double disk refiner, 20°. Bar width 2 mm
Specific edge load: 0.6 J/m
Furnish

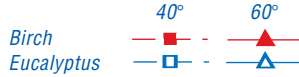

Fig. 5: Influence of specific edge load on tensile strength for hardwood pulps.

Double disk refiner, 20°. Bar width 2 mm
Cutting angle: 40°
Furnish

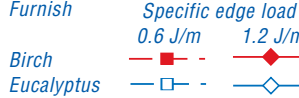
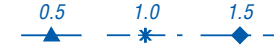

Fig. 6: Influence of specific edge load on tensile strength for deinked pulp.

Double disk refiner, 20°. Bar width 2 mm
Cutting angle: 60°
Furnish 50 % ONP / 50 % OMG
Specific edge load [J/m]



Conclusions

With optimum refining equipment, there is no problem in meeting the paper industry’s requirements for refining low-resistance fibres. Refiner operation should be at low specific edge loads below 1.0 J/m and fillings should have a high cutting edge length. Optimum cutting angles vary according to furnish, and have to be established by carrying out trials. Such trials can be undertaken in the Voith Sulzer Stock Preparation Research and Development Centre. Eucalyptus and birch require a cutting angle of 40°, whereas mixed tropical hardwood and deinked pulp should be refined with a cutting angle of 60°. The influence of cutting angle on development in strength properties is much higher than the influence of bar width. The overall result of low intensity refining is optimum strength and optical properties, higher refiner efficiency and lower specific refining energy.

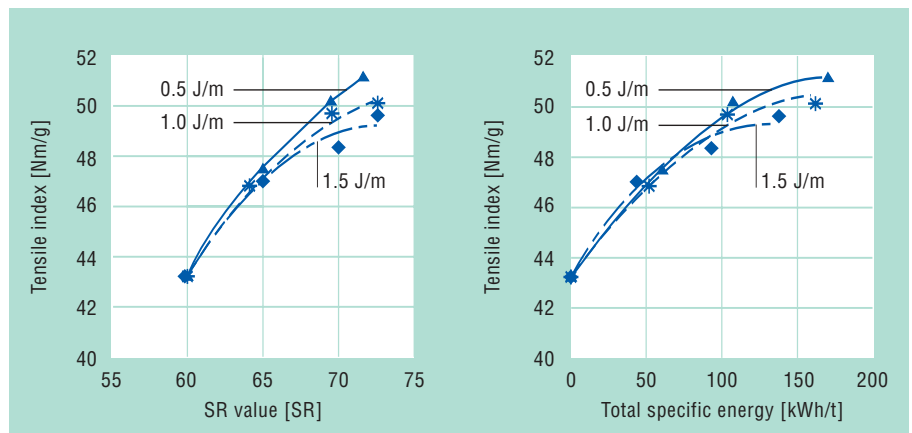
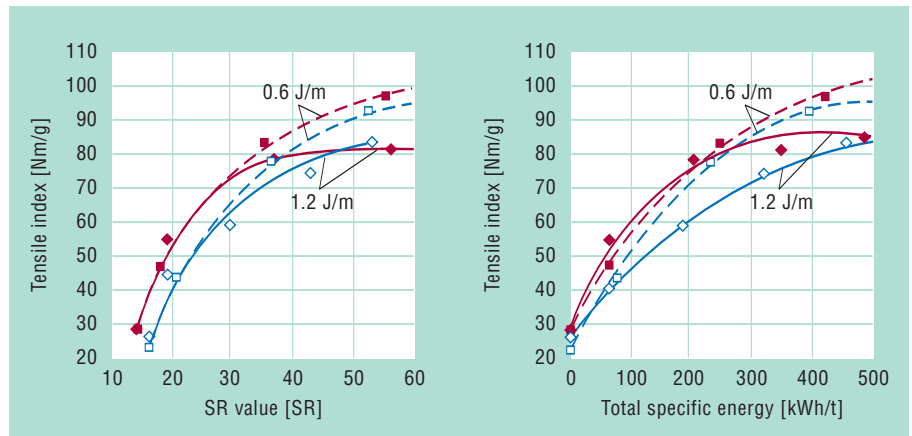
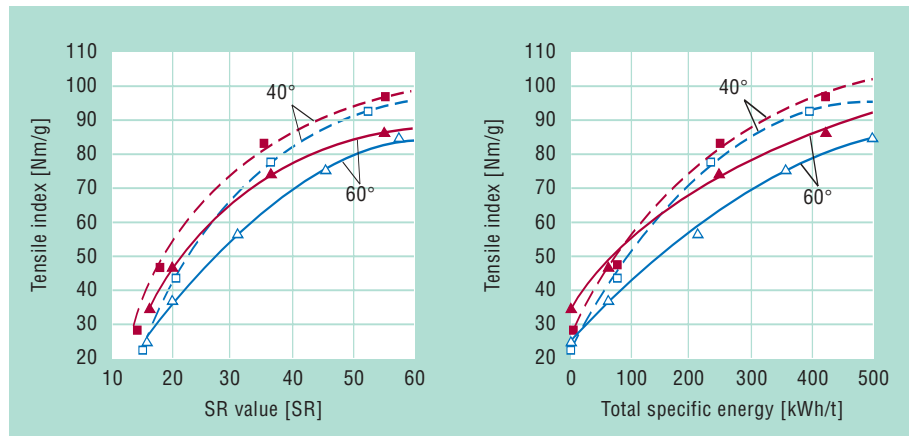

For further details refer to Voith Sulzer Stock Preparation leaflet st.SD.09.0007.GB.01

Stock Preparation Division:

“Pick-up Method” confirmed as TAPPI Test Method – a new process for stickies measurement

As a supplier of systems and individual machines, Voith Sulzer Paper Technology is necessarily involved in comprehensive technological studies. Our laboratories are therefore constantly evaluating stock and paper samples from development trials or from the production of our customers. Everybody must be able to rely on the results of these measurements, both we and our customers. It is therefore important to us that exact, reproducible and clear measurement results are obtained and that the measuring methods are also available to everyone.

In many cases standardized measuring methods are available, but there is as yet no world-wide standard for measuring stickies. It was precisely for this reason that many years ago Escher Wyss developed their own internationally accepted measuring process for macro-stickies, which are heated and pressed under conditions similar to those in a paper machine. When a superimposed cellulose nitrate filter is removed, they tear material out of the filter, allowing stickies to be measured as white spots.

In the meantime, things have changed quite a bit. The prepared stock should contain fewer and fewer stickies, and preparation systems have become correspondingly more effective. However, the measurement of smaller quantities of stickies presents a tremendous challenge to measuring systems.

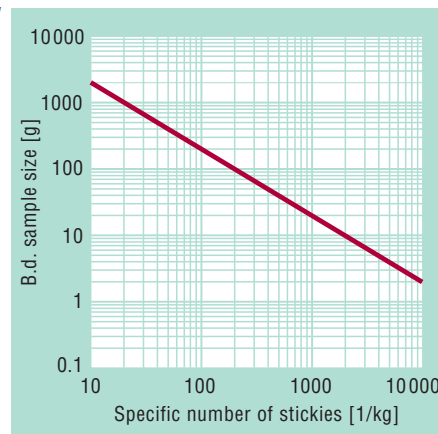

In order to satisfy today's demands, Voith Sulzer Paper Technology has fully revised and improved the original Escher Wyss method with due consideration to three features:

- Theoretical determination of the required sample size, independent of the method to be used
- Simplified measuring process
- Expanded (size specific) data evaluation.

The result of this development is the “Pick-up Method”, used by Voith Sulzer as standard method since January 1997.

Determination of the required sample size

Using statistics, the sample size required to measure a pre-determined number of stickies to the required accuracy can be calculated (Fig. 1). Conversion of the number of stickies into a stickies area is possible if sufficient measuring data is

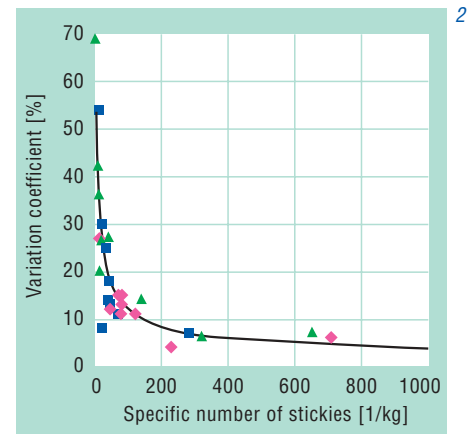

available. For stickies loads of 400 stickies per kg stock (corresponding to approx. 100 mm²/ kg) or more, a sample size of 100 g is sufficient to obtain a measuring accuracy of $\pm 20\%$ (see Fig. 1). With the Pick-up Method 100 g samples are normally evaluated. If the number of stickies is below 400 per kg/stock, at least one further 100 g sample must be evaluated.

The calculated accuracy for various stickies concentrations with a 100 g sample (Fig. 2) has been confirmed by a number of tests.

Simplified measuring

To be able to evaluate 100 g samples with an acceptable amount of effort, the Somerville laboratory screen was used to wash out the stickies. The cellulose nitrate filters used with the Escher Wyss method were replaced with specially coated paper, which can be processed easily and quickly and which consider-

Fig. 1: Required sample sizes, if the measured number of macrostickies is to show a probability of 80% with a confidence interval of $\pm 20\%$.

Fig. 2: Experimental testing and confirmation of the measuring accuracy for a sample size of 100 g.
 — Calculated variation coefficient for a confidence interval of $\pm 20\%$.
 No. of repeat measurements:
 ● 9 ○ 6 ○ 3

Fig. 3: Process of the Pick-up Method for measuring of macrostickies.

Fig. 4: Application example for the specific logarithmic area density as expanded data evaluation. Change in size distribution of macrostickies in a deinking process
 — Inlet hole screening
 — Accepts hole screening
 — Accepts slot screening
 — Finished stock

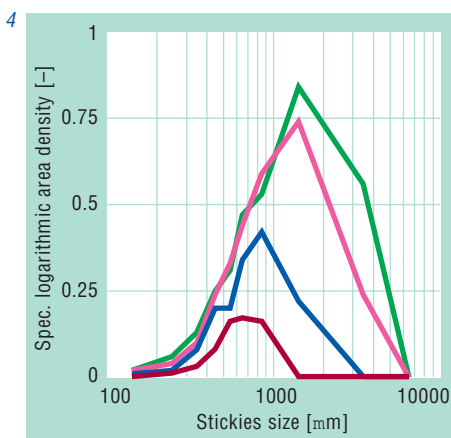

ably reduces the amount of work per measuring point.

The complete process of the pick-up method is illustrated in Fig. 3 (A-H). The process generally corresponds, for instance, to the earlier Escher Wyss method or the INGEDE method. The main difference is in the use of the practical special coating for marking of the stickies and the reduced amount of work involved.

Expanded data evaluation

The analytical image evaluation of the white dots is normally carried out by size classification, but up to now only the total area and number have been consid-

ered. An illustration of the area density distribution shows the size distribution of the stickies in a sample and, when compared with several other samples, it supplies some interesting information on the effect of individual machines or process sections on the stickies loading of the stock (Fig. 4).

The Pick-up Method is a stickies measuring process with defined and proven measuring accuracy which can also be used to reliably and practically evaluate samples with low stickies loadings.

The following persons were involved in the development of this method: Dr. Bangji Cao, Johannes Dehm, Oliver Heise, Herbert Holik, Almut Kriebel and Dr. Samuel Schabel.

For further details of the Pick-up Method, refer to Voith Sulzer Stock Preparation Leaflet st.SD.01.0011.GB.01

Now declared the official
TAPPI Test Method
No. TAPPI T 277 pm-99
 for measuring macrostickies.

Paper Machinery Divisions:

Dagang – successful startup of an unprecedented project



*The author:
Andreas Köhler,
Paper Machinery Division
Graphic*

The biggest order ever booked since the founding of Voith Sulzer Paper Technology was successfully completed not long ago. Since February 6, 1999 Dagang PM 1 has been operating, and on May 2, PM 2 went on line as well.

Dagang is a greenfield mill located three hours from Shanghai on the Yangtse-Kiang river. On a site covering more than six square kilometres, a production centre has arisen in an amazingly short time. The impressive scale of this plant reflects China's determined efforts to cover domestic paper needs increasingly from own resources, at the same time modernizing its papermaking technology to world leader standards.

Apart from the two production lines recently started up, the plant already includes a new coating machine with

coating kitchen, a modern paper roll storage with roll transport, winding and packaging, a roll workshop with roll grinder, additional workshops, an on-site power station and extensive effluent treatment facilities. With all the necessary infrastructures already in place – from access roads to housing and canteen facilities – several more paper machines can follow the first two.



The Voith Sulzer Paper Technology erection and commissioning team being congratulated by the customer after the successful startup of PM 2.



Technical data of Dagang PM 1 and PM 2:

*Design speed 1,700 m/min
Wire width 10,500 mm
Sheet width on popereel 9,800 mm
Jumbo roll diameter 3,600 mm
Jumbo roll weight max. 110 tonnes
Output per line 1,450 tonnes/day
Winder speed up to 2,600 m/min
Roll diameter at winder up to 1,600 mm.*

Customer

Asia Pulp & Paper Co. Ltd. (APP) is Asia's largest papermaking corporation outside Japan. The headquarters of APP, which has greatly expanded its activities in recent years, are situated in Singapore. The technical centre in Serpong, Jakarta, provides technical support for Indonesia's numerous paper and pulp mills. APP also has a joint venture with the Chinese company Gold East Paper, Dagang (Jiangsu province), who own the new Dagang plant among others.

Scope of supply

After an intensive negotiation and planning phase, Voith Sulzer Paper Technology were awarded the order on February 6, 1997 for two complete production lines for coppaper and film-coated offset (FCO) paper with a basis weight range of 40 to 90 g/m². The consortial scope of supply also covered complete stock preparation and plant electrification in-

cluding paper machine drives. As consortium leader, Voith Sulzer Paper Technology carried full responsibility for the entire scope of supply, including technical equipment inside the PM building. With the exception of civil works and civil construction, Voith Sulzer Paper Technology thus supplied a complete turnkey paper mill.

Quality aspects

The customer had already reached contractual agreement with Voith Sulzer Paper Technology on key component suppliers, emphasizing a preference for European and US manufacturers.

A key factor in trouble-free commissioning was consistently high quality thanks to comprehensive control measures. Critical components were manufactured by Voith Sulzer Paper Technology. Purchased parts were handled by a special procurement team within the purchasing orga-

nization. Suppliers were advised and monitored by production experts, who also supervised acceptance testing. Only dependable suppliers were used, with new suppliers being subjected to quality inspection and evaluation. All quality control was based on predetermined criteria and certification plans, both with respect to suppliers and own fabrication.

Project planning and design

Project coordination meetings were held on a regular basis, alternately in Indonesia and Germany. As soon as the Gold East Paper project office opened, all meetings were held on site in Dagang. Since the time available for design work was extremely limited, first deliveries were due in Dagang by February 1998 in order to meet the tight erection and start-up schedules. With two months required for transport and customs handling, less than ten months remained between receipt of order and shipping.

Fig. 1: PM 1 stock preparation and disc filter.

Fig. 2: PM 1 soft calender.

Fig. 3: PM 1 Speedsizer.

Fig. 4: TORO winder.

Fig. 5: PM 1 DuoReel.



Logistics and erection

Once again, Voith Sulzer Paper Technology was put to the test by an extremely tight manufacturing and pre-assembly schedule for both paper machines including headbox, former, press section, Speedsizer, soft calender, DuoReel and all three winders. Furthermore, large-scale logistics coordination of all suppliers had to be mastered within five months. No less than 1,400 tonnes of sheet metal was delivered from Spain alone for fabricating the vats and other vessels. Final delivery involved shipping 1,500 containers and 500 giant crates to China – not to mention the crane girder and a paper machine roll which disappeared somewhere in the Indian Ocean...

Site erection was carried out by Chinese contractors, supported by a Voith Sulzer team of up to eighty erectors from 15 different countries. Work continued over Christmas and New Year 1998/99, which in China is not a holiday. Site communication problems with the Chinese were solved by engaging a team of interpreters.

Commissioning and startup

After checking the control system and carrying out final tests and adjustments, the stock preparation line and approach flow section with headbox and former were first commissioned. "Stock on wire" on PM 1 was attained on January 15, 1999 as per plan. On February 6 – four

days before the scheduled deadline – PM 1 was started up (“paper on the reel”). Startup speed was 1,100 m/min, and by April a daily output of 1,160 tonnes had been reached with a speed of 1,300 m/min. Right from the outset, product quality was so good that saleable paper deliveries were possible shortly after startup.

PM 2 was commissioned according to plan, with “stock on wire” on April 8 and “paper on the reel” on May 2.

Voith Sulzer Paper Technology is contractually servicing both production lines with on-site personnel until January 2001. In view of the enormous investment involved, this is understandable and reflects the customer’s satisfaction with this highly successful project.

Scope of supply per production line: turnkey delivery except for civil works

Paper machine components

- ModuleJet headbox
- DuoFormer CFD with DuoCleaner for top wire cleaning
- DuoCentriNipcoFlex press with 2 NipcoFlex rolls
- Single tier pre-dryer section: 9 dryer groups (47 cylinders) with DuoStabilizers, DuoCleaner in the first dryer group, ropeless tail threading and water jet tailcutter
- Speedsizer for sizing or pigmenting, with Airturn, infra-red and hot air dryers, tail threading with Fibron conveyors and rope system
- Afterdryer section: single tier with DuoStabilizers and DuoCleaner in dryer group 10, double tier in groups 11 and 12, with VentiStabilizers, water jet tailcutter and ropeless tail transfer
- Soft calender with 2 stacks, Nipcorect roll in stack 1 with thermo-oil system, ropeless tail threading with 10 Fibron conveyors
- DuoReel
- Mechanical drive components
- Dryer hood and machine related air handling
- Steam and condensate systems
- Hydraulics and pneumatics, control and instrumentation
- Oil lubrication system
- 2 complete sets of clothing for each paper machine
- Sets of spare parts
- Erection supervision
- Commissioning and training
- Long-term service support
- 2 TORO winders for PM 1
- 1 TORO winder for PM 2



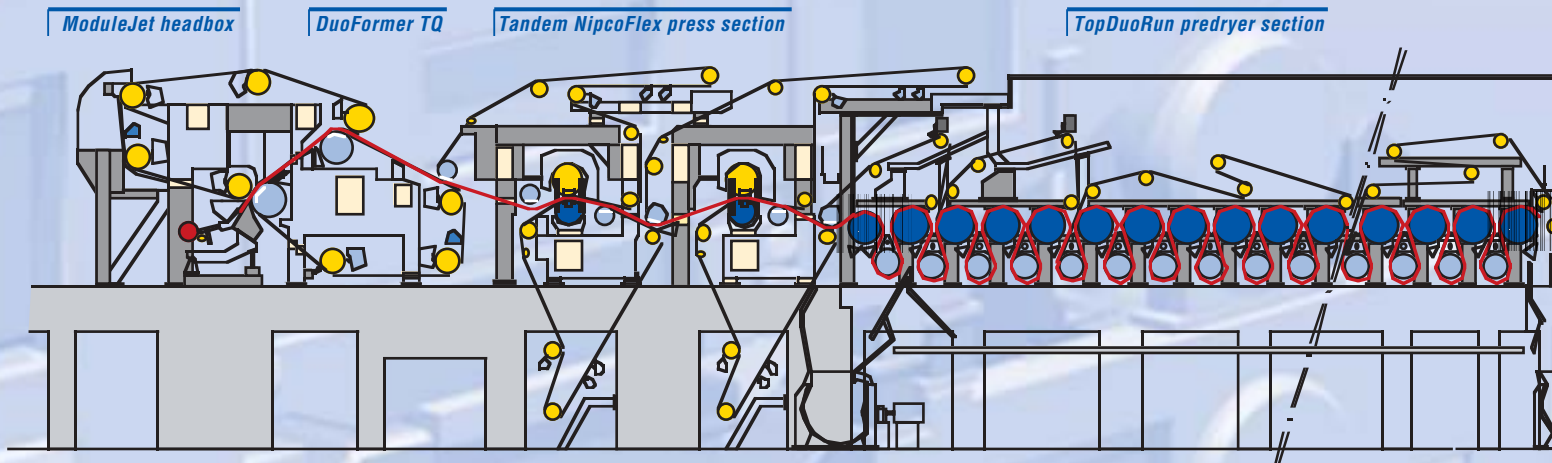

Paper Machinery Divisions:

Soporcel 2 – Europe's largest capacity fine paper machine



*The author:
Dieter Babucke,
Paper Machinery Division,
Graphic*

Last January Voith Sulzer Paper Technology was awarded an order by Soporcel Portugal for a wood-free graphical paper production line. This order is all the more notable in view of stiff competition by Valmet, who supplied the customer with PM 1 in 1990.

In June 1984 SOPORCEL (Sociedade Portuguesa de Cellulose) started producing bleached eucalyptus pulp at a greenfield mill on the Atlantic coast between Lisbon

and Porto. The new mill was officially opened by President General Ramalho Eanes on October 18, 1984.

This pulp mill was Portugal's most important industrial project during the eighties, and its output of 400,000 t.p.a. is still the highest in the country.

The Lavos site near Figueira da Foz covers 170 hectares, leaving plenty of room for putting the company's long-standing



View of the new PM 2 building.

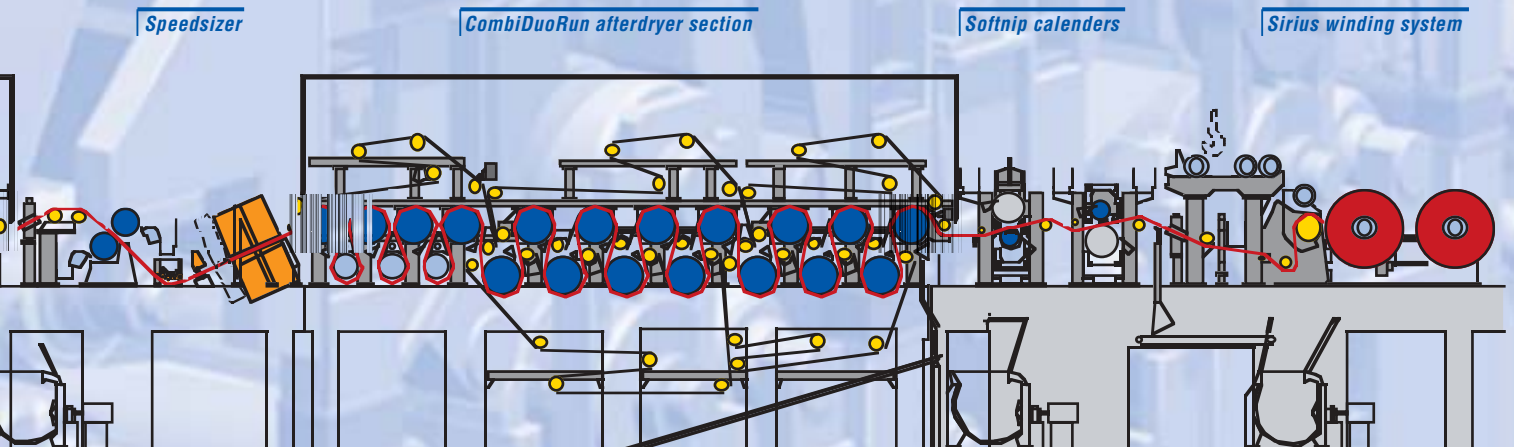

expansion plans into effect. Accordingly, a new paper machine started up in May 1991 which produces some 270,000 t.p.a. of wood-free copying and offset printing papers. After more than two years of technical discussions and negotiations, Soporcel (now renamed Sociedade Portuguesa de Papel) finally signed a contract with VSPT on January 19, 1999 for delivery of the new PM 2. Startup is scheduled for around mid-2000, thus realizing the original plan for

integrating pulp and paper production on the Lavos site.

The VSPT scope of supply covers stock preparation refiners for the eucalyptus pulp, screenes for the approach flow section, the complete paper machine with controls, and the process control and status monitoring system. The scope of supply also includes two roll winders with complete roll packaging and transport system.

Technical data of the new PM 2

Wire width 9,350 mm

Web width on reel 8,650 mm

Max. winding diameter 3,500 mm

Design speed 1,700 m/min

Max. drive speed 1,700 m/min

Production capacity 400,000 tonnes p.a.

Paper grades: wood-free writing and printing, 60 - 100 g/m²

Design basis weight: 80 g/m²

Startup: third quarter 2000



Voith Sulzer Paper Technology is thus supplying this customer with a state-of-the-art production line incorporating the latest technology in graphical paper production.

This will be the world's first fine paper machine to operate at speeds as high as 1,700 m/min. And to celebrate the new millennium, it will hold the European record for graphical paper production capacity.

Main components

MasterJet

This headbox with ModuleJet and Profilmatic M (to be updated to Profilmatic MQ) offers the following benefits:

- Optimum basis weight cross-profile
- Optimum fibre orientation profile
- Optimum formation.

DuoFormer TQ

This gap former is based on the roll blade principle with D unit, a formation concept which ensures:

- good retention thanks to initial sheet formation on the forming roll
- high quality formation thanks to pulsations in the D unit
- symmetrical sheet formation (anisotropy).

Tandem-NipcoFlex

Press section with two double-felted shoe presses. This concept brings the following advantages:

- Symmetrical drainage top and bottom
- Gentle drainage for volume preservation
- High dry content at high speeds (reduced risk of brakes)
- Draw-free transfer to the dryer section.

TopDuoRun predryer section

All drying cylinders are at the top, with vacuum rolls below for web stabilization.

Advantages:

- Closed run from press section to Speedsizer
- Reduced cross-machine web shrinkage
- Less breakes
- Ropeless tail threading

Speedsizer

For surface application of starch with profiled applicator rods.

Advantages:

- Uniform volumetric starch application
- Thermal stability of applicator beams to ensure good profiles right from the start
- Improved Fibron vacuum tail transfer (VTT) system
- Optimal web run over AirTurn, with contact-free air drying

- IR dryers can be retrofitted for future application of pigments and coating colours.

2 soft-nip calenders

with zone-regulated Nipcorect rolls and heated thermorolls for correcting surface roughness and thickness.

Tasks:

- Equal 2-sided surface roughness correction to the prescribed values
- Volume preserving calendering by thermorolls at prescribed temperatures
- Good cross-machine profiles of roughness and volume thanks to Nipcorect technology.

Sirius winding system

with two center drives, for constant contact line-force irrespective of the reel spool movement.

Advantages:

- Good winding quality up to the largest diameters
- Line force independent of reel spool movement
- Line force control unaffected by paper roll weight
- No lateral sheet deviation during winding
- No air intake into the nip.



Paper Machinery Divisions:

CPI Biron PM 25 rebuild – a success story



*The author:
Gareth Jones,
Voith Sulzer Paper Technology
North America, Appleton*

In June 1957, the Biron Division of Consolidated Papers, Inc. (CPI) started up a new paper production line, which was on the cutting edge of paper making and coating technology. It boasted a pressurized headbox, suction pickup device, roll coater, continuous broke system, enclosed hood and even a strain gauge roll weighing system before the supercalenders.

Biron 25 was to become an important machine for CPI, with the LWC paper produced making it the favored production line of Time magazine for many years. Eventually, however, the time came when the limited capability of the equipment could no longer keep up with the increasing demands on sheet quality of newer printing techniques.

Approximately three years ago, realizing that the production line needed considerable upgrading in order for the product to regain its preeminent position in the market, CPI began to work hard to specify the necessary work. The project gained approval in October 1997, and the rebuild was off and running. Voith Sulzer Paper Technology in Appleton, Wisconsin, (VSAW) was chosen for supply of almost all the process equipment and received an order on November 6, 1997.

Prior to beginning the project, CPI's environmental staff obtained all the necessary environmental permits to ensure the production line's continued compliance with all environmental regulations. The rebuild was to be the most extensive ever carried out by CPI.

Fig. 1: PM 25 after the rebuild.

Fig. 2: The PM-team.

Fig. 3: The off-line blade coater.

Fig. 4: Dr. Ron Swanson, Senior Vice President, CPI.



The CPI and VSAW project teams, with a long experience of working together, were quickly off the mark and the project got under way. Overall project guidance at CPI came from Bill Orcutt, senior vice president. He was supported by Mark Casper, project manager, and several other highly qualified and experienced team members. Harald Blank was the project manager for the Voith Sulzer team.

With this crew, the project moved smoothly and rapidly, directly through to completion. CPI did the detail engineering and construction with their own people. Only at the peak period, an additional 500 contracted people supplemented

The Voith Sulzer Paper Technology (VSPT) equipment, by machine section, was as follows:

- GapJet headbox with ModuleJet for dilution control and Profilmatic M profile control
- DuoFormer* CFD
- DuoCentri NipcoFlex* press section (shoe press in 3rd nip)
- Under machine press and couch pulpers
- Steel basement frame for the wet end
- Wet end lube system
- Coater automatic unwind Flying Splice
- Blade coater stations with Profilmatic C
- Deaerators for coater stations
- Gas infra-red dryers plus Impact electric infra-red profiling dryers
- Hot air airfloat dryers
- Complete new framing and web run
- TR type hydraulic reel





3

the 220 CPI employees working on the project.

Ron Swanson, senior vice president of CPI, commented, *“What I am most impressed with was the excellent communication and cooperation between Voith Sulzer Paper Technology and Consolidated Papers, Inc. – starting with design and pre-work, all the way through the staging of delivery of components through project management. My salute to the entire team including Voith Sulzer, Consolidated Papers’ corporate engineering and purchasing, the Biron production team, our mill maintenance and crafts people, all the CPI support and staff and the contractors.”*

PM 25 shut down for the rebuild on January 17, 1999, the rebuild being planned for 65 days. The coater started up after only 50 days, with the paper machine following six days later on March 14th. After 24 hours the first paper reached the reel and salable paper was being pro-

duced. The start-up and subsequent ramp up of production has been fast and almost trouble-free, with everyone concerned delighted at the project’s overall effectiveness and success.

“Under budget, ahead of schedule and quality output – this project is an engineering masterpiece.” said Gorton M. Evans, president and CEO. *“The project is a tribute to the engineers, craftspeople, construction workers and production employees who dedicated themselves to*



4

doing such a top-notch job in record time.”

Bill Orcutt commented on the exceptionally short time taken to complete the project and the excellent safety performance throughout the rebuild. The total cost of the rebuild is expected to come in below budget.

This project has once again shown that various Voith Sulzer entities are capable of working well together to optimize our performance in better serving a customer’s needs. Our plants in Appleton, Heidenheim, Brazil and Middletown all contributed significantly to the supply and the project’s success, thereby helping to maintain the very special relationship we enjoy with an extremely important customer – Consolidated Papers, Inc.

Our congratulations go to CPI for a project very well done.

Paper Machinery Divisions:

MasterJet F/B – the great little headbox for demanding needs



The author:
Klaus Lehleiter,
Paper Machinery Division
Graphic

As shown by this latest member of our headbox family, Voith Sulzer Paper Technology's R&D effort focuses not only on large aggregates – optimized solutions for smaller paper machines are also on the agenda (Fig. 1).

Development grounds

This new product is justified by the numerous smaller paper machines still in operation today, including board and packaging paper production. In line with the Voith Sulzer philosophy – optimal efficiency and cost-effectiveness for each

individual application – a lower-cost alternative to the standard MasterJet F headbox was required for smaller paper machines. All the advantages of a hydraulic headbox had to be retained.

Since this market segment is often served by local suppliers of small paper machinery, our success depended on upholding Voith Sulzer quality standards as well as on competitive pricing. The new MasterJet F/B headbox therefore had to meet our high criteria for technological and product quality.

Design principles

The greatest challenge in headbox development is to ensure a parallel output gap as far as possible during operating conditions. This is particularly important when using dilution technology with the ModuleJet (Fig. 2). Local deformations due to the nozzle pressure and thermal expansion caused by the stock temperature have to be prevented or compensated. A precisely parallel nozzle and slice geometry is indispensable for uniform paper fibre orientation in machine direction.

To meet this requirement cost-effectively, the following design criteria were set for developing the MasterJet F/B headbox:

- Greatest possible symmetry to the direction of flow
- No high components over the machine width

- Module design to be independent of width
- No long weld seams
- Minimal material outlay
- Minimal machining.

Implementation of design principles

For the greatest possible symmetry to the direction of flow, the bottom half of the headbox was completely redesigned. The lower wall of the nozzle is no longer supported conventionally on a single welded apron board, but on numerous individual support elements in the same way as the upper nozzle wall support of the MasterJet F.

The headbox thus comprises several individual force transmission elements:

- Baseplates and ribs in the bottom half
- Anchor plates and support segments in the turbulence tube block
- Hinged bearings and ribs in the upper half.

Continuous cross-machine elements are only used for closing off and/or sealing stock flow paths.

With this low-thrust construction principle, Voith Sulzer has pioneered a new era in headbox design. No thermal expansion or nozzle pressure forces distort the parallelity of the slice opening (Fig. 3). Deformations in the cross-machine direction cause only a slight obliqueness of individual ribs, but no inadmissible local

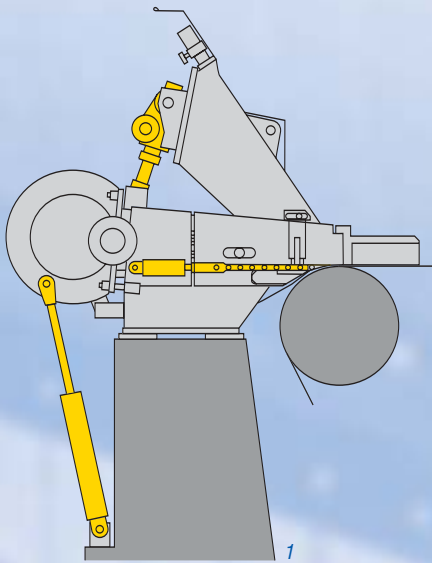

deformation of the nozzle. The main advantage of this low-thrust design is that no heating chambers and no separate heating system are required for headbox temperature compensation.

Headbox manufacture therefore becomes much more cost-effective. On the one hand no welding outlay is required for heating chambers, and on the other hand the turbulence generator no longer has to be designed as a heat exchanger.

Furthermore, this modular cross-machine construction retains all the benefits of the C-clamp design principle:

- Uniform design independent of width
- Minimal force transmission to the machine foundations.

Another outstanding feature of the new MasterJet F/B headbox is that the bottom lip can be horizontally displaced for adjusting the jet impingement point. Synchronized hydraulic cylinders on the operator and drive sides move the bottom lip and deckle plate assembly together as a single unit (Fig. 3).

This eliminates sealing problems between the bottom lip and the deckle plate. The junction between the bottom lip and the turbulence generator is closed off by a sliding plastic element with felt and rubber seal.

A linear-stroke flow divider ensures par-

Fig. 1: MasterJet F/B headbox with slice lip adjustment (side view).

Fig. 2: MasterJet F/B headbox with ModuleJet.

Fig. 3: Finite element headbox stress analysis under operating conditions.

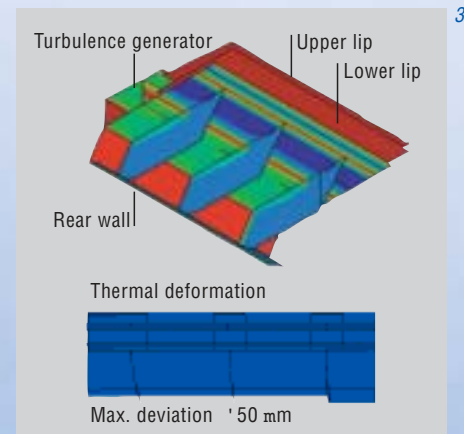

allel motion of the bottom lip on the operator and drive sides.

Since basis weight profile quality demands are by no means lower on small production plants than on large ones, the MasterJet F/B headbox is fitted with local slice lip adjustment or with a ModuleJet dilution water system, depending on application.

Summary

The MasterJet F/B is the latest member of the Voith Sulzer headbox family for paper machines operating at speeds up to 800 m/min. The systematic implementation of innovative design principles has led without sacrificing quality to a compact, space-saving headbox with only a few moving parts. With the new MasterJet F/B headbox concept, Voith Sulzer Paper Technology thus offers another customized module enabling further optimization of the papermaking process.

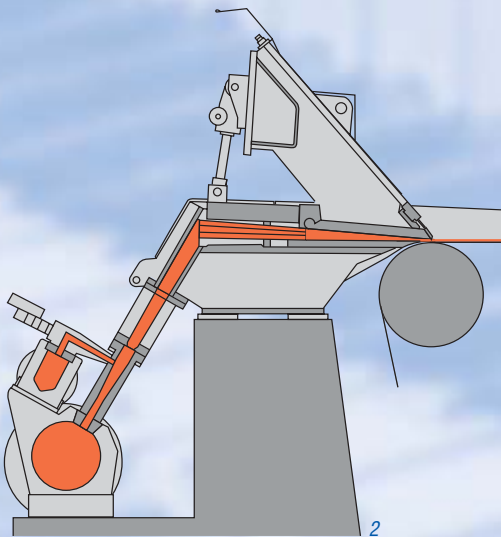

Paper Machinery Divisions:

From Minutes to Seconds – new perspectives in paper quality



The authors:
Rudolf Münch, Ulrich
Paschold, Dieter Ende,
Paper Machinery Division
Graphic

Uniform paper characteristics in both dimensions are a decisive quality factor. This particularly applies to the basis weight distribution, which has a key influence on productivity.

In modern fast-running paper machinery, the paper sheet is stressed to the limit. This is true not only in paper machines, but also during following processing stages such as printing presses. Only absolutely homogeneous paper can stand up to this kind of stress and to the further increasing demands expected in future. Likewise for high quality finishing, uniformity of the base paper is essential – it defines the homogeneity of coating, and thus of smoothness, gloss and printability.

In view of this situation, Voith Sulzer Paper Technology has developed a new system which reduces profile deviations to an unprecedented degree. This is a further development of the ModuleJet dilution water system. The ModuleJet actuators are now equipped independently with intelligent control systems. With rapid-response autonomous control loops, this enables them to ensure uniform fibre distribution prior to sheet formation. The control setting time lasts only a few seconds instead of the several minutes previously required.

Cross direction (CD) profile adjustment with ModuleJet

Since introduction of ModuleJet in 1994, dilution water technology has become

state-of-the-art. Prior to 1994, headbox slice adjustments were the only way of adjusting cross-profile deviations, with the serious drawback that basis weight improvements were at the expense of fibre orientation. ModuleJet operates with a parallel gap, while for basis weight profiling stock consistency is adjusted in zones by controlled feeding of dilution water.

This enables CD-profile improvements of more than 50% compared with conventional headboxes – without negatively affecting the other sheet characteristics.

However, only very long-wave deviations in the machine direction could be controlled with the existing technology. This was due on the one hand to slow measurement of sheet characteristics (typically 30 seconds each scan), and on the other hand to process transport dead-time:

Up to now, sheet characteristics have been measured at the end of the paper machine, just before winding. However basis weight adjustment is done by stock feed control well before the paper machine. And from this point it takes 1 minute or more until the paper characteristics are finally measured. Since even the most sophisticated control systems are not able to overcome this process deadtime, quality deviations took several minutes to be corrected.

In other words, profile deviations were not detected until they had already existed for 1.5 minutes – which at today’s production speeds often means 20,000 square metres or more of faulty paper. On top of this, it still took a considerable time for automated control systems to correct such deviations.

The only way to solve this problem is by adopting a completely new approach, whereby most deviations are measured and corrected before sheet formation even starts. With such a new system, quality improvement takes a few seconds now instead of several minutes as previously required.

Profilmatic MQ – system overview

Since stock consistency behind the headbox nozzle defines the basis weight of the product, it must remain stable for optimal product quality.

To ensure this stability, the stock consistency must be continuously measured. The best measuring point is where the last adjustments are made **prior** to sheet formation, i.e. in the individual ModuleJet mixing units (Fig. 1).

Following the Voith Sulzer Paper Technology “Progress in Process” principle, we developed a sensor small enough to fit inside each mixing unit. Despite its small size, this sensor is highly accurate: it measures up to 2.0% stock consistency to a precision of 0.005%.

Fig. 1: Stock consistency measurement in a ModuleJet mixing unit.

Fig. 2: Measurement of stock consistency and fillers content.

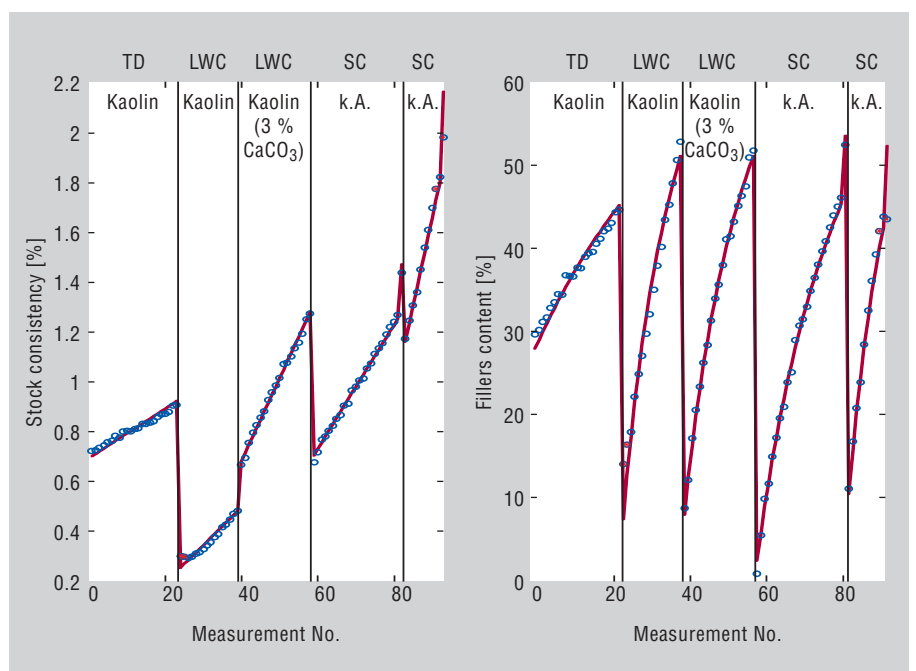
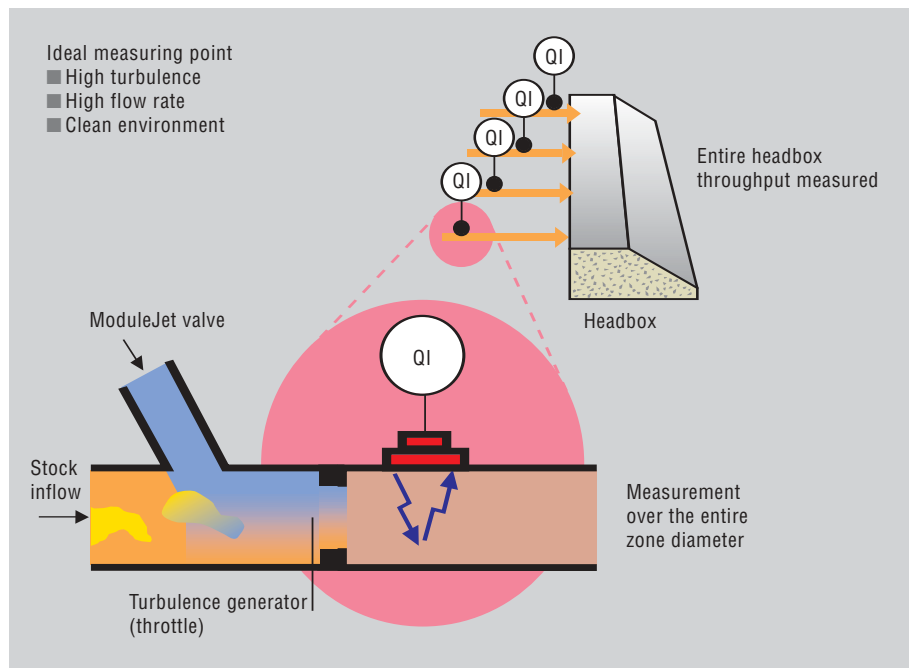
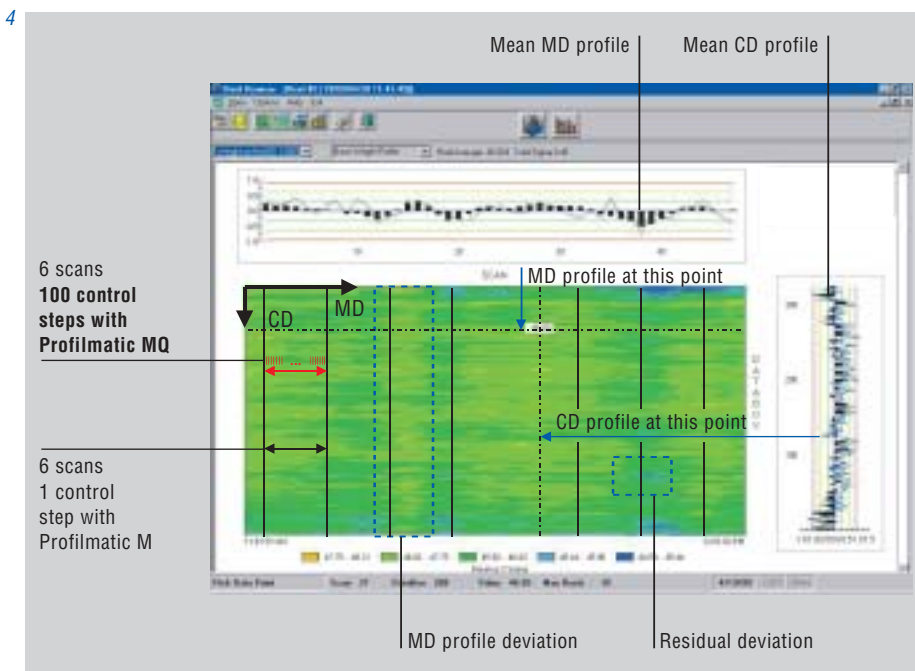
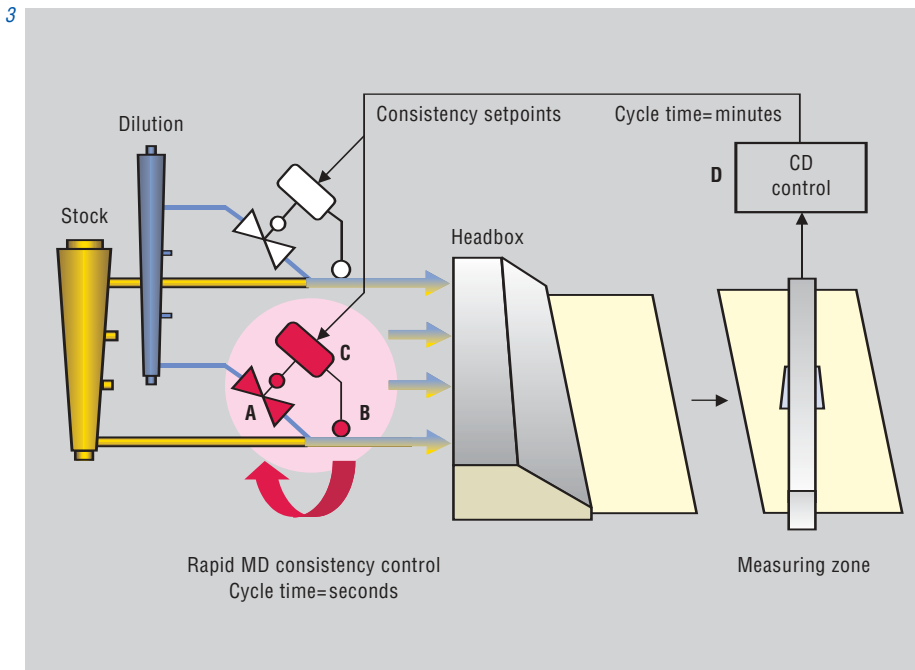

Fig. 3: Profilmatic MQ system overview.

- A ModuleJet dilution water valve
- B ConSense consistency sensor
- C ProfilTronic Intelligent control element
- D Profilmatic MQ CD-profile control.

Fig. 4: Reel profile overview with InfoPac.



As a result, stock consistency can be measured every second in each headbox zone, also differentiating between fibres and fillers.

Fig. 2 shows stock measurements of consistency and fillers content of the same furnish. The continuous line represents the actual values given by the laboratory, while the circles indicate readings taken with the new stock consistency sensor. Although the same sensor calibration was used for all furnish, these measurements correspond remarkably well.

These sensors measure the consistency in cross and machine direction to a resolution according to actuator spacing. This forms the basis for innovative control loops with extremely fast response, because the measuring point and the mixing valve for adjusting local consistency are only a few millimetres apart. Since each control element has autonomous intelligence, consistency is automatically kept constant in this short loop.

The consistency setpoint for the ModuleJet units is computed from scanner signals in the same way as for the existing Profilmatic M. This second control loop is dominating and slower (Fig. 3). It ensures that basic quality criteria are met, while the local consistency control system prevents short-term quality fluctuations.

Deviations due to non-homogeneous

stock composition are thus corrected before entering the paper machine.

Practical advantages

The most obvious advantages of the Profilmatic MQ are as follows:

- Much smaller machine-direction and residual profile deviations
- Much smaller CD-profile deviations
- Faster grade changes.

On modern paper machines, CD-profile deviations are significantly less than machine-direction and residual profile deviations. With ModuleJet headboxes, online measurement generally shows CD-profile 2Δ values smaller than 0.2 g/m^2 , while machine-direction and residual profile deviations can be several times greater.

Overall profile plots with a large number of scans (Fig. 4) clearly indicate by colour changes how seriously quality is affected both by deviations in machine direction and by random basis weight deviations (residual deviations). This diagram, plotted by Voith Sulzer InfoPac, shows the raw paper profiles over an entire reel. At the top and on one side of the diagram are the mean profiles in the machine and cross-direction (black bars) and the raw profile at a selected point on the diagram. The time between scans was about 20 seconds.

Taking the consistency in the approach flow of a typical paper machine as a

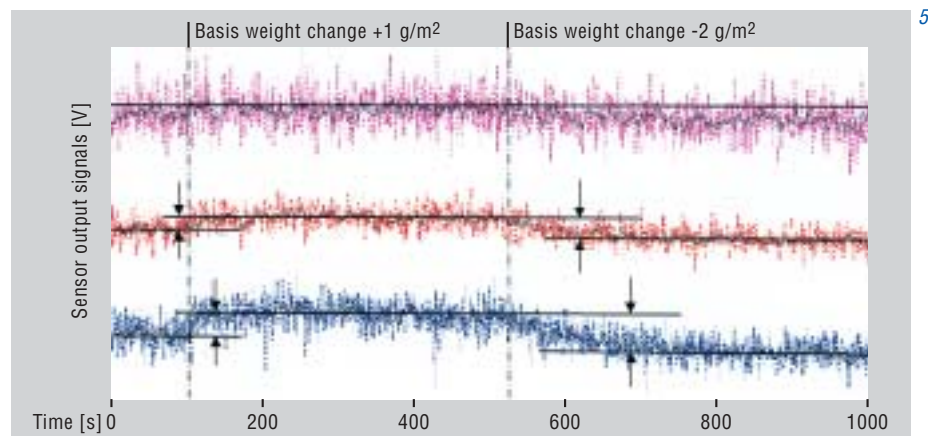
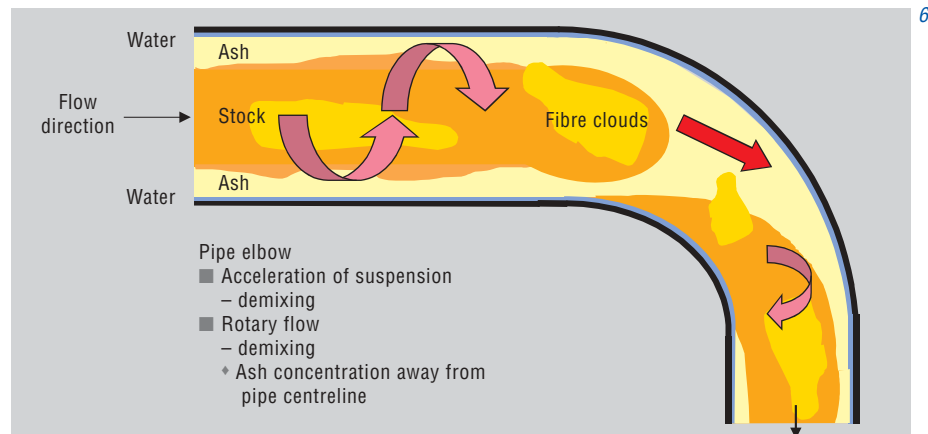

Fig. 5: Rapid consistency fluctuation.

Fig. 6: Demixing in pipes.



reference, rapid consistency fluctuations appear at intervals of 3 to 4 seconds. Fig. 5 shows output signals from the new consistency sensor during basis weight changes on a paper machine. Improvement potential here is clearly substantial – and this is where the new Profilmatic MQ comes into its own.

Measuring the stock consistency in the headbox shows the actual deviations in basis weight distribution well before the

stock arrives on the wire. These deviations can thus be detected in the high frequency range by the fast-response consistency control system, and corrected accordingly.

On the pipe walls in the boundary layer zone, stock consistency is very low. Furthermore, demixing occurs in large diameter pipes, especially after pipe bends. Due to rotary flow, ash tends to concentrate away from the pipe centreline. This

leads to fibre clouds and streamline formations, so that effectively each zone of the headbox is supplied with a different stock grade (Fig. 6). Careful design of the approach flow section can minimize this problem, but not solve it completely.

Such random consistency fluctuations at the headbox inlet side have a delayed effect particularly in wide machines. They reach the opposite side of the headbox up to 5 seconds after they entered.

Generally, these effects and all machine direction fluctuations lasting less than one minute are termed residual deviations, since according to online measurements they do not cause any long-term deviations in machine or cross-direction. However, the fast-response consistency control loops used for ModuleJet valves detect these deviations and take corrective measures.

Apart from machine-direction and residual profiles, online displayed CD-profiles are also improved by the Profilmatic MQ. The reason for this is not clear at first sight, since there are no changes with respect to the control valves. There are two main reasons: Firstly, the online displayed CD-profiles are filtered in machine direction. Each new raw profile is only partly affecting the display, which in fact represents the average of the last ten raw profiles (unfiltered individual measurements).

Due to the reduction of short-term machine-direction and residual deviations, however, all the raw profiles exhibit less deviations than before – and the displayed average profile is of course better as well. In other words, the lower overall profile deviations are reflected in better CD-profile values.

The second reason is the way in which readings are taken. The new consistency sensors are operating in parallel, while traditional scanners measure sequentially along a diagonal path. Since the machine speed is much higher than the scanning speed, scanners are effectively machine-direction profile sensors which move across the web very slowly.

No conclusions can thus be drawn from individual profile measurements on CD-profile stability. This has to be computed from several individual scans, which also limits the minimal possible time between two CD control steps. This basic drawback is avoided by the parallel sensors used in the Profilmatic MQ. They enable rapid determination of the true cross-profile – and hence much faster CD-correction.

The new Profilmatic MQ is also a unique tool for reducing grade change time. Particularly with only slight grade changes, transition zones are minimized to the point where only the very end of the reel is affected.

The net result of all these possibilities is greater productivity, thanks to:

- better runnability due to more homogeneous sheet formation
- less waste due to shorter grade change time
- a clearer process insight for more effective troubleshooting
- better finishing.

Measuring the CD consistency profile in the headbox gives a completely new process insight. Profile troubleshooting thus becomes much easier and faster. Here again, higher productivity is achieved. Last but not least, finishing processes such as coating and calendering also profit from this new system. Since the raw paper is more homogeneous, the product gloss, smoothness and printability are also improved.

Summary

Voith Sulzer has developed an innovative control system for improving paper product homogeneity. Four systems of this type have already been sold, and the first startups are currently underway. The Profilmatic MQ substantially reduces profile deviations in machine and cross-direction, thus setting new standards in paper quality. The importance of this new technology is reflected by the ever-increasing web stress in today's fast-running paper machines and printing presses, and rising quality demands for printability.

Paper Machinery Divisions:

Procart – Latin America’s most advanced board machine



The author:
Harald Nowotny,
Paper Machinery Division

In 1995, one of the leading paper manufacturers in Latin America, Empresas CMPC S.A., decided to further extend its market position – the largest and most advanced board machine of Latin America was to be built. Excellent reference installations, the Voith Sulzer negotiating team’s knowledge of the Spanish language and cooperation over many years were some of the reasons that, after detailed negotiations, the board machine order was placed with Voith Sulzer Paper Technology. Today, the Planta Maule plant – also known in the past as Procart – is reality. It belongs to the subsidiary “Cartulinas CMPC S.A.” and has an output of 150,000 tons/year.

Goal of the investment

With the new plant, the CMPC group quadrupled its folding boxboard production. It, thus, positioned itself as a reliable supplier capable of meeting customer requirements in terms of quality and capacity and satisfactorily supplying the demand. At the same time, CMPC strengthened its local leading position.

Located in the village of Yervas Buenas, 250 km south of Santiago, Chile, the new mill is close to the CMPC-owned “Pinus Radiata” forests. The fibers of this pine species deliver the main furnish for the new board machine.

Also, the existing infrastructure of the area, with a hydroelectric power station securing the energy demand of the mill and the nearby port of Talcahuano, were important factors for selecting this location.



Fig. 1 and 2: The Planta Maule plant is located in Chile, 250 km south of Santiago.

Fig. 3 and 4: The new board machine.

Wire width: 5,400 mm.

Trimmed width: 4,800 mm.

Design speed: 650 m/min.

Machine length: 240 m.

Production capacity: 150,000 tons/yr.

Grades: coated folding boxboard, 220-450 g/m²

corrugated medium, 110-190 g/m²

linerboard, 126-300 g/m²

Startup: June 2, 1998.

When the investment was made, an important aim was to fulfill the high demands placed on the new plant in terms of product and manufacturing process quality, as well as environmental compatibility. The use of advanced technologies was to set new standards in these fields.

The product and its requirements

After an investment of US Dollar 230 million, CMPC runs the new mill with highly qualified personnel and up-to-date technologies, making products which fulfill the highest demands and meet world standards.

The availability in Chile of “Pinus Radiata” long fiber permits CMPC to produce high-quality folding boxboard from long fiber pulp at a good cost/performance ratio. The use of this pulp type in the outer board layer gives high stiffness values at low basis weights. This, in turn, delivers savings to the customer.

For giving high bulk to the board, refined mechanical pulp – also from “Pinus Radiata” – is used for the middle ply at a defined pressure and controlled temperature. The crossed and intertwined fibers form an open fiber fabric with air cavities

resulting in a light structure with a high volume. This structure has a low weight; fines, dust and fiber fragments are completely eliminated.

The combination of RMP fibers and “Pinus Radiata” long fiber pulp permits making folding boxboard on the Maule plant that features high strength, high bulk, and an optimum surface with good printability. Cutting and punching of the board is accomplished with minimum dust formation.

Environmental aspects

All equipment, processes and products of the new mill fit into CMPC’s company policy making environmental protection through efficient use of raw materials and energy a must.

Use of the most advanced technologies ensures that the current environmental protection regulations can easily be met. The Maule plant is also fitted with specific equipment for the disposal of effluents and solid waste. Plantation-grown wood is the only wood source for board production at Planta Maule, which ensures the raw material supply on a long-term basis.

3

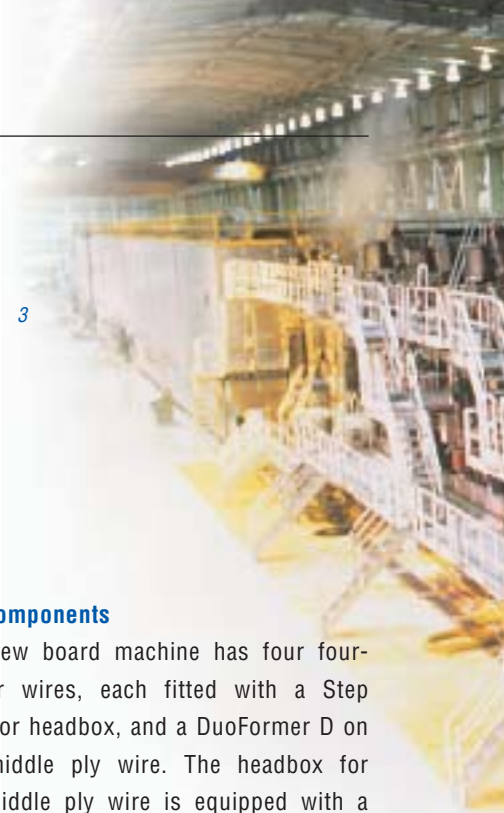

The components

The new board machine has four four-drinier wires, each fitted with a Step Diffusor headbox, and a DuoFormer D on the middle ply wire. The headbox for the middle ply wire is equipped with a ModuleJet water dilution system for CD profile control. The DuoFormer D ensures sufficient drainage at high basis weights and improves formation. The top ply wire is equipped with a dandy roll.

The top ply wire is run with 100% kraft pulp, the undertop ply wire with RMP and PM broke, the middle ply with RMP and OCC or with RMP and kraft pulp, and the back ply wire with a furnish ranging from 100% OCC to 100% kraft pulp.

The current press section configuration includes a suction press and two straight-through presses. The first two presses are double-felted, the third press is single-felted and features a Nipco roll in the top position. Installation of a NipcoFlex shoe press in the second position is being planned.

CMPC placed great attention to the quality characteristics of high bulk, good paper surface and optimum smoothness. The

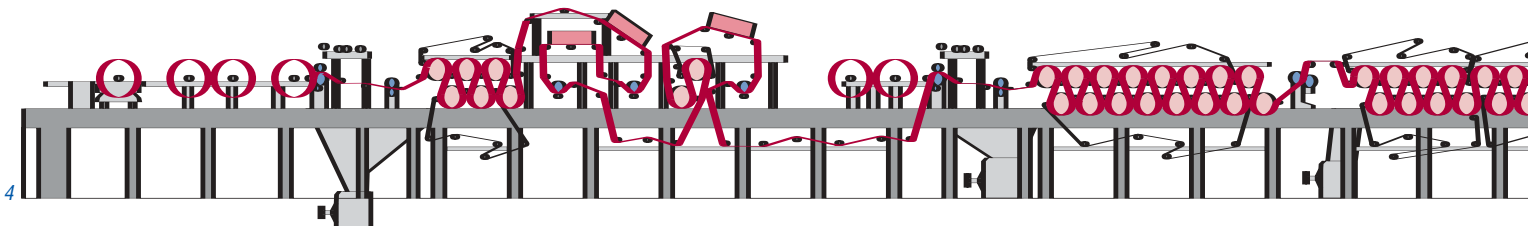

4

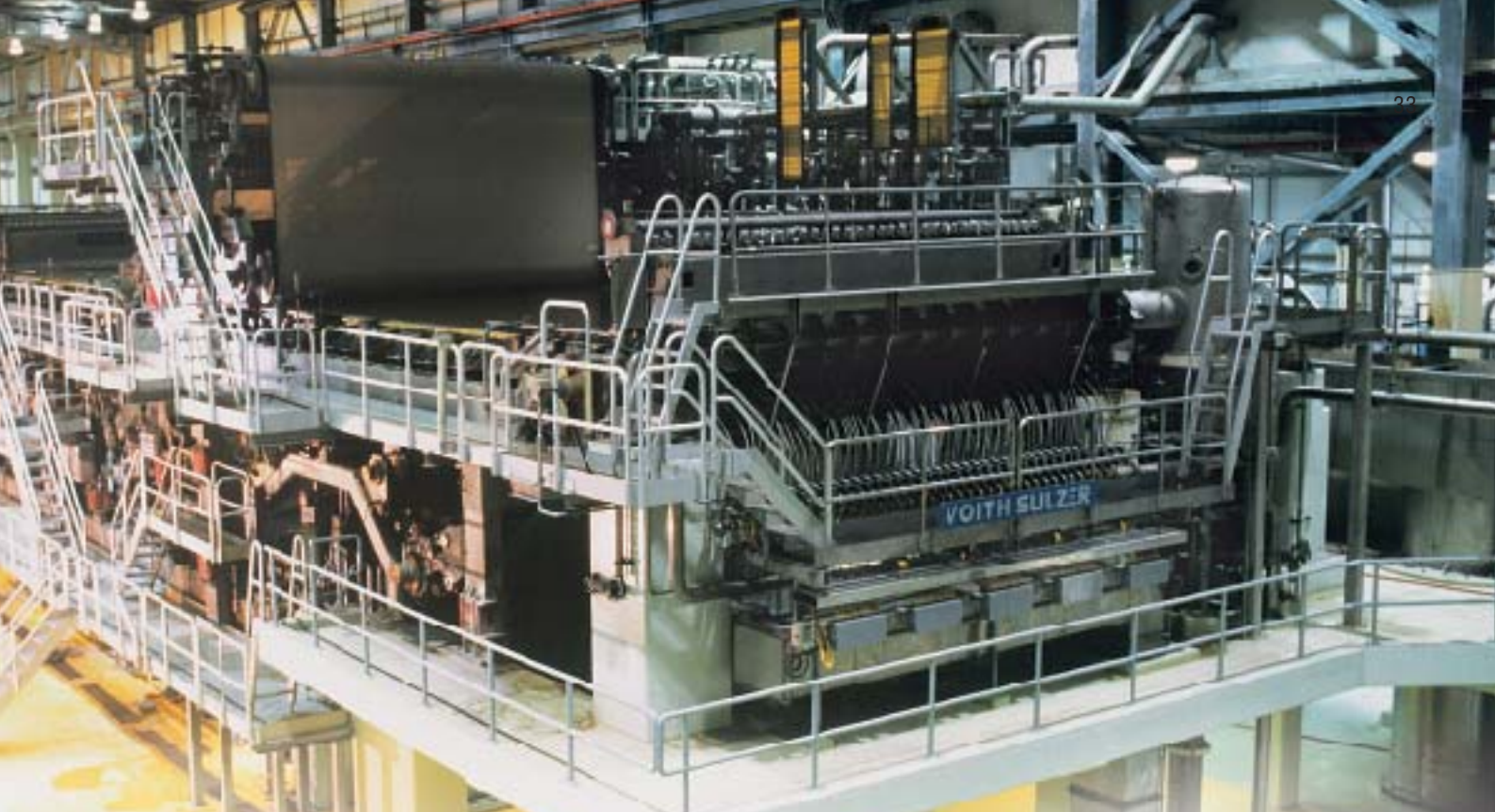

machine, therefore, was ordered with an MG cylinder, a size press, hardnip and softnip calenders and an online coating machine. With a diameter of 6.7 m, the MG cylinder is one of the largest worldwide.

Initially, since liner and corrugated medium also were to be produced, the board machine was equipped with two horizontal reels. The first reel is used for winding liner and corrugated medium. Folding boxboard is carried via a complex rope guiding system over the reel drum of the first reel into the coating machine and wound up on the second reel.

In addition to the board machine, Voith Sulzer Paper Technology also delivered the stock preparation lines for pulp and RMP, the approach flow systems and the water and broke systems. The RMP plant was supplied by Andritz Inc.

As the board machine is to be extended for a folding boxboard production of approximately 200,000 tons/year, replacement of the second press with a NipcoFlex shoe press at a later stage was designed into the first concept. It is further planned to re-position the size press and convert it into a Speedsizer, as well as extend the after-dryer section into the area of the first reel. The coating system will be fitted with a third coating unit for the top ply, and back ply coating will be supplemented with a Speedsizer or SpeedFlow for pre-coating.

Startup

After site assembly and performance testing, the first trials with water and stock were run in late April 1998. In the following three to four weeks, the board machine was run intermittently. The reason was to make the personnel familiar with the new board machine and ensure smooth and trouble-free operation. In

addition, the optimum settings of the production parameters were to be found. Production was started with the back ply wire only, then the middle ply wire and the undertop ply wire were taken into operation. In this phase, corrugated medium and liner grades were produced. At that point the top ply wire and the online coating machine started up to begin actual folding boxboard production.

The official startup of the board machine took place on June 2, 1998, when continuous production of coated folding boxboard commenced. The subsequent optimization phase included repeated production of the entire production program (110-450 g/m²). The quality parameters and physical paper properties were optimized. Special attention was given to the reproducibility of the technological board characteristics. The plant currently produces coated folding boxboard of superior quality.

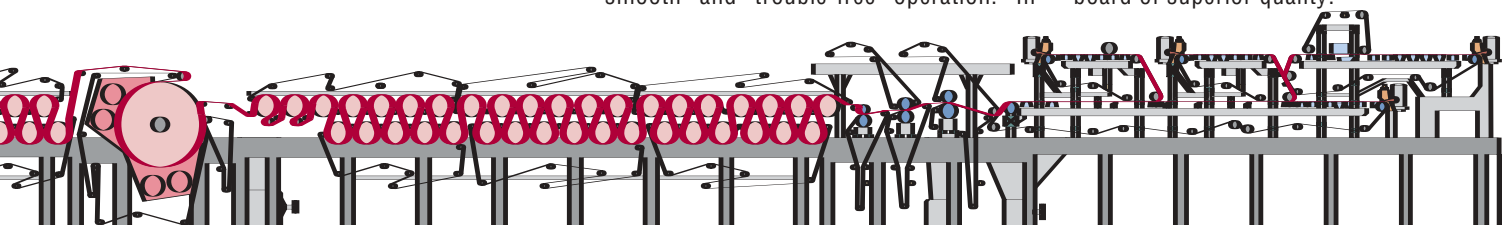

Paper Machinery Divisions:

S.A.I.C.A. – the worldwide fastest paper machine for corrugated medium



*The author:
Helmut Riesenberger,
Paper Machinery Division
Board and Packaging*

S.A.I.C.A. – A quantum leap in packaging paper machine speed

Early this year, Sociedad Anónima Industrias Celulosa Aragonesa (S.A.I.C.A.) in Spain placed an order for a new state-of-the-art packaging paper machine with the Paper Machine Division Board and Packaging.

The new production line for corrugated medium sets new standards for packaging paper production speeds. While the fastest packaging paper machines currently run at around 1,070 m/min, the maximum operating speed of the new plant is 1,450 m/min. The machine will be taken onstream in September 2000.

The investment is in line with a trend that has been observed on the packaging paper sector in recent years. New, thinner flute profiles and permanent cost pressure are driving forces for a reduction in corrugated medium basis weights. To maintain the productivity of the paper machines, they have to be operated with increased speeds. In addition, an advanced machine design has to ensure

fulfilment of the high standards placed on paper quality.

The modern machine concept of PM 9 at S.A.I.C.A. is customized to the quality requirements of corrugated medium.

The MasterJet G headbox produces a low MD/CD strength ratio and thus creates optimum preconditions for further handling in the corrugated board process. The headbox is fitted with the proven ModuleJet system for cross profile control and ensures stable basis weight profiles with particularly low variance.

Also the new DuoFormer Base ensures optimum utilization of the fiber potential in terms of strength. It delivers good formation and high drainage. Optimized water run permits simple handling and low energy consumption.

Paper run in the DuoCentriNipcoFlex press is fully closed, ensuring maximum dry contents and runability.

Machine runability is a central feature also in the TopDuoRun dryer section: The



Fig. 1: (left to right): O. Heissenberger, Executive Vice President, Voith Sulzer Papiermaschinen GmbH St. Pölten, Austria; H. Müller, President and CEO, Voith Sulzer Papiertechnik, and J.M. Balet, Chairman of S.A.I.C.A., signing the contract of sale.

Fig. 2 and 5: S.A.I.C.A. PM 9
Wire width: 8,100 mm
Design speed: 1,500 m/min
Production capacity: 350,000 tons/yr
Grade: Corrugated medium, 75-110 g/m².

Fig. 3: SpeedFlow PM 9.

Fig. 4: Sirius Reel PM 9.

paper web is permanently supported by the dryer fabrics, which minimizes paper breaks. The DuoRun groups are fitted with DuoStabilizers for further stabilization of the paper web. Paper threading is ropeless.

Surface sizing is accomplished with the first SpeedFlow used for corrugated medium.

The paper is finally wound on the first Sirius Reel for packaging paper machines. It permits winding diameters up to 3,900 mm and ensures optimum roll buildup and uniform reels, thus boosting paper machine productivity even further.

Voith Sulzer Paper Technology's scope of supply includes also the entire stock preparation system for optimum coordination of the entire production process.

The new order has been preceded by a series of successful board and packaging paper machine projects. Thus, between 1995 and 2001, Voith Sulzer Paper Technology delivered or is going to deliver and put into operation 29 completely new board and packaging paper machines.

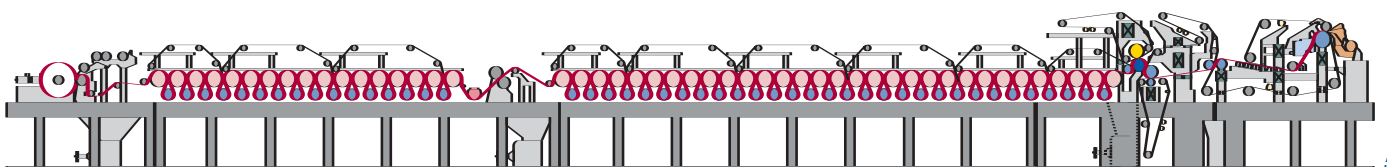
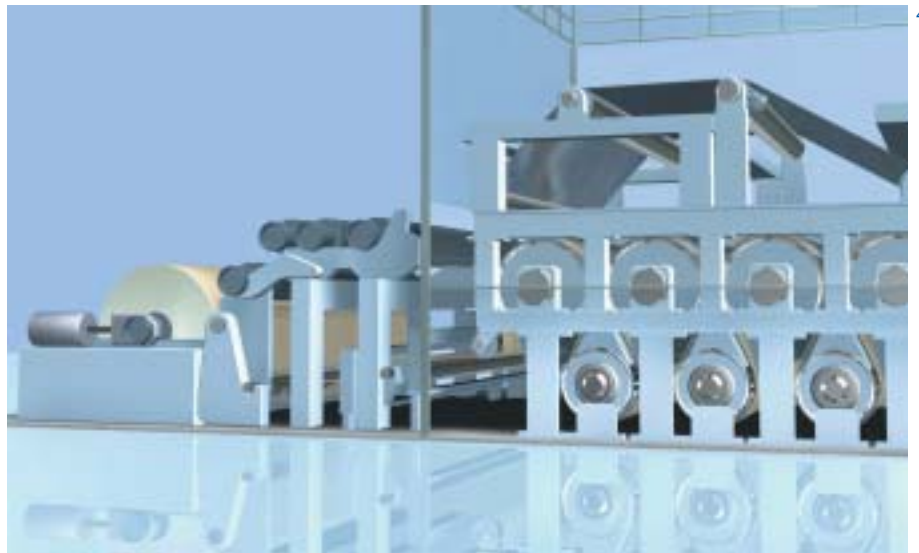
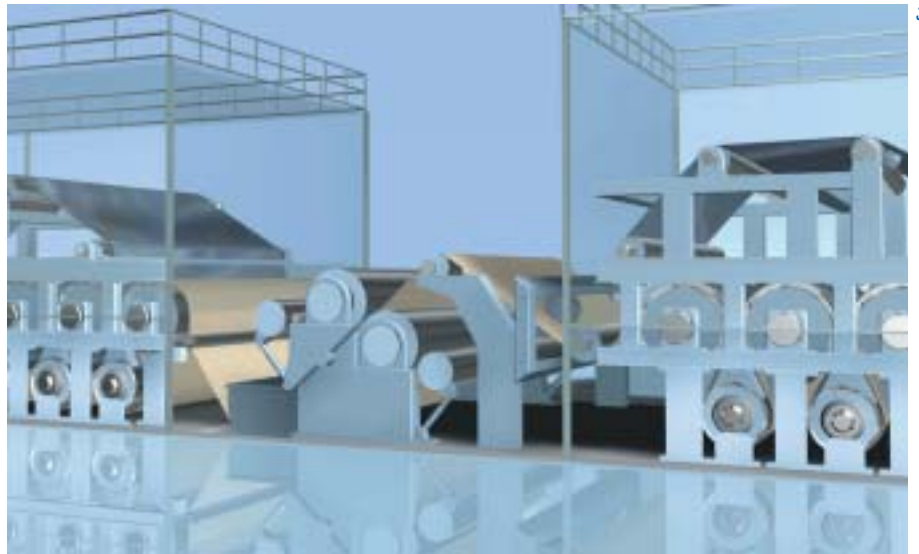



Paper Machinery Divisions:

Rizhao – another complete board production plant for China to strengthen market leadership

At the beginning of this year, Shandong Rizhao Wood Pulp Co. Ltd. in Rizhao, China, placed an order for a new board machine with Voith Sulzer Papiermaschinen AG in St. Pölten, Austria.

Rizhao is the Chinese word for “sunrise” and it lies on the Eastern coast of China, north of Shanghai, close to the town of Qingdao. Rizhao was chosen years ago by Chinese governmental authorities as the location of a greenfield project. In addition to the board machine, the new plant comprises a pulp mill for the production of 170,000 t/y of bleached pulp. The project is to be financed by a credit provided by the Japanese Exim Bank.

After the tendering procedure, the order was won against the competition of Beloit and Valmet. Decisive factors were the modern technological concept of Voith Sulzer Paper Technology and the successful references in Asia.

During the state visit of the President of the People’s Republic of China, Jiang Zemin, to Austria the contract was signed in the presence of the Chinese President



*To the pictures:
The contract was signed by Mr. Mao Jichun, President of Shandong Rizhao Wood Pulp Co. Ltd., Mr. Wang Huiheng, President of CNTIC, and Prof. Dr. Franz Silbermayr, CEO of Voith Sulzer Papiermaschinen AG at the Imperial Hofburg Palace in Vienna in the presence of the Chinese President, Jiang Zemin, and the Austrian Federal President, Dr. Thomas Klestil.*

and the Federal President of the Republic of Austria, Dr. Thomas Klestil.

The order comprises a production line for the manufacture of liquid packaging board and high quality folding boxboard from a virgin fiber furnish. Apart from the board machine with a wire width of 4,100 mm and a design speed of 600 m/min, the order includes: stock preparation to be delivered by the Austrian Andritz AG, ancillary systems such as steam and condensate system, heating and ventilation, vacuum equipment, slitter-winder and coating preparation (Cellier) as well as controls and instrumentation including the quality control system by ABB. The board machine will partially be manufactured at Liaoyang Voith Sulzer Co.Ltd., where roll and cylinder manufacturing workshops with modern equipment are available. Startup of the plant is scheduled for mid-2001. Details on the new mill will be given at a later time.



Finishing Division:

Janus MK 2 – fruit of more than 20 Janus calenders



*The author:
Thomas Hermesen,
Finishing Division*

At the end of 1995, the Janus calender concept was launched at Voith Sulzer Finishing Division's new R&D centre in Krefeld. After numerous customer trials, the benefits of this calendering technology were acknowledged by the

paper industry worldwide: greater output with better product quality at the same time! More than 20 Janus calenders sold since then, the majority of which now in service, have confirmed these benefits in everyday production.

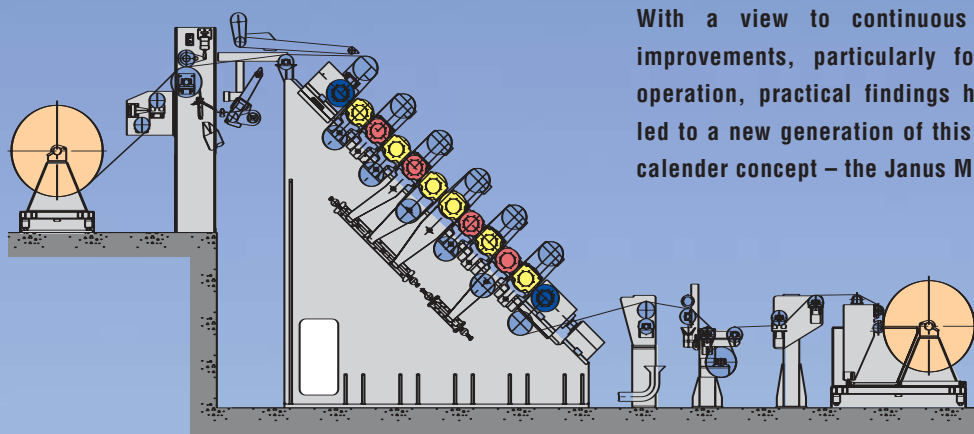

With a view to continuous product improvements, particularly for online operation, practical findings have now led to a new generation of this modular calender concept – the Janus MK 2.

The new concept

The Janus MK 2 concept was presented to the paper industry in August 1998. To better demonstrate the advantages of this new calender, we converted our test facility accordingly on receipt of the first order (Figs. 1 and 2).

All the innovations of the Janus MK 2 concept are now incorporated in this modified test facility:

Variable calendaring areas

The Janus MK 2 provides for individual line force settings in each nip, thus enabling variable calendaring areas. This new generation of the modular Janus concept therefore meets today's demands for precisely customized calendaring according to product. Our test facility incorporates no less than 12 calendaring areas, covering the entire range of modern production requirements.

With all rolls closed, 11 nips are available (Fig. 3). This operating mode is used for optimizing conversions of existing supercalenders to Janus technology. In the same way as a supercalender, the test facility also incorporates upper and lower unheated deflection compensation rolls (Nipco K) without soft cover. Bypassing individual nips allows for additional calendaring areas (Figs. 4 to 7).

By locking the middle Nipco K roll, the stack is divided (with open nip) into two

halves, each with individual line force adjustment (Fig. 8). Calendaring areas are varied either by running only one of the two stack halves (Figs. 9 and 10), or by reversing the direction of roll rotation in the lower stack half (Fig. 11). The latter operating mode is used e.g. for one-sided calendaring of special paper grades. Here again, further operating modes are possible if individual nips are bypassed. Duo-nip and single-nip operating modes (Figs. 12 and 13) are enabled by locking the respective heating rolls.

The last calendaring area is used for producing matt paper surfaces (Fig. 14). To this purpose the Nipco F roll bearing arms are lowered to close the matt nip, while all other nips remain open. Thanks to automated adjustment of the various calendaring areas, customer trials can be carried out on this test facility with extreme flexibility. A wide variety of paper grades can thus be produced with only one calender.

Improved pressure distribution

All the above-mentioned calendaring areas can be adapted to product requirements as follows:

- by compensating for so called overhanging loads (normal compensation), thus causing a slightly rising stack line force characteristic
- by compensating additionally for the total roll weight (full compensation), which results in an identical line force charac-

teristic in all nips. The 45° layout as such has a positive influence on the line force characteristic, since it reduces the roll weight component in the pressing direction to about 70%. Compensation forces are thus reduced simply by exploiting the calender layout.

User-friendly roll changing

Rolls are lifted hydraulically from the calender stack so that they can be removed by the shop crane without requiring any special tools (Figs. 15 and 16).

Rolls can even be changed during calender operation provided that the web travel is suitable. A web travel allowing on-the-run roll changes is given for instance when the calender is operated in the matt or single-nip mode. This gives customers the benefit of greater flexibility, particularly with a Janus MK 2 calender integrated into the paper machine.

More rigid foundations

The 45° layout enables a considerably larger contact area between the frames and foundations. This makes the calender much more rigid and vibration-proof – an important advantage with today's steadily rising production speeds and web widths.

Easier accessibility

Specially designed mobile service platforms greatly facilitate accessibility and service work on the guide-rolls, calender rolls, doctor blades and steam showers

*Figs. 1 and 2 (previous page):
Janus MK 2 test facility at the Krefeld R&D
centre.*

Fig. 3: 1 x 12 roll mode.

Fig. 4: 1 x 10 roll mode.

Fig. 5: 1 x 8 roll mode, changeover nip at top.

Fig. 6: 1 x 8 roll mode, changeover nip at bottom.

Fig. 7: 1 x 6 roll mode.

Fig. 8: 2 x 5 roll mode.

Fig. 9: 1 x 5 roll mode, stack 1.

Fig. 10: 1 x 5 roll mode, stack 2.

Fig. 11: 2 x 5 roll mode, 1-sided.

Fig. 12: Duonip mode.

Fig. 13: Single nip mode.

Fig. 14: Matt nip mode.

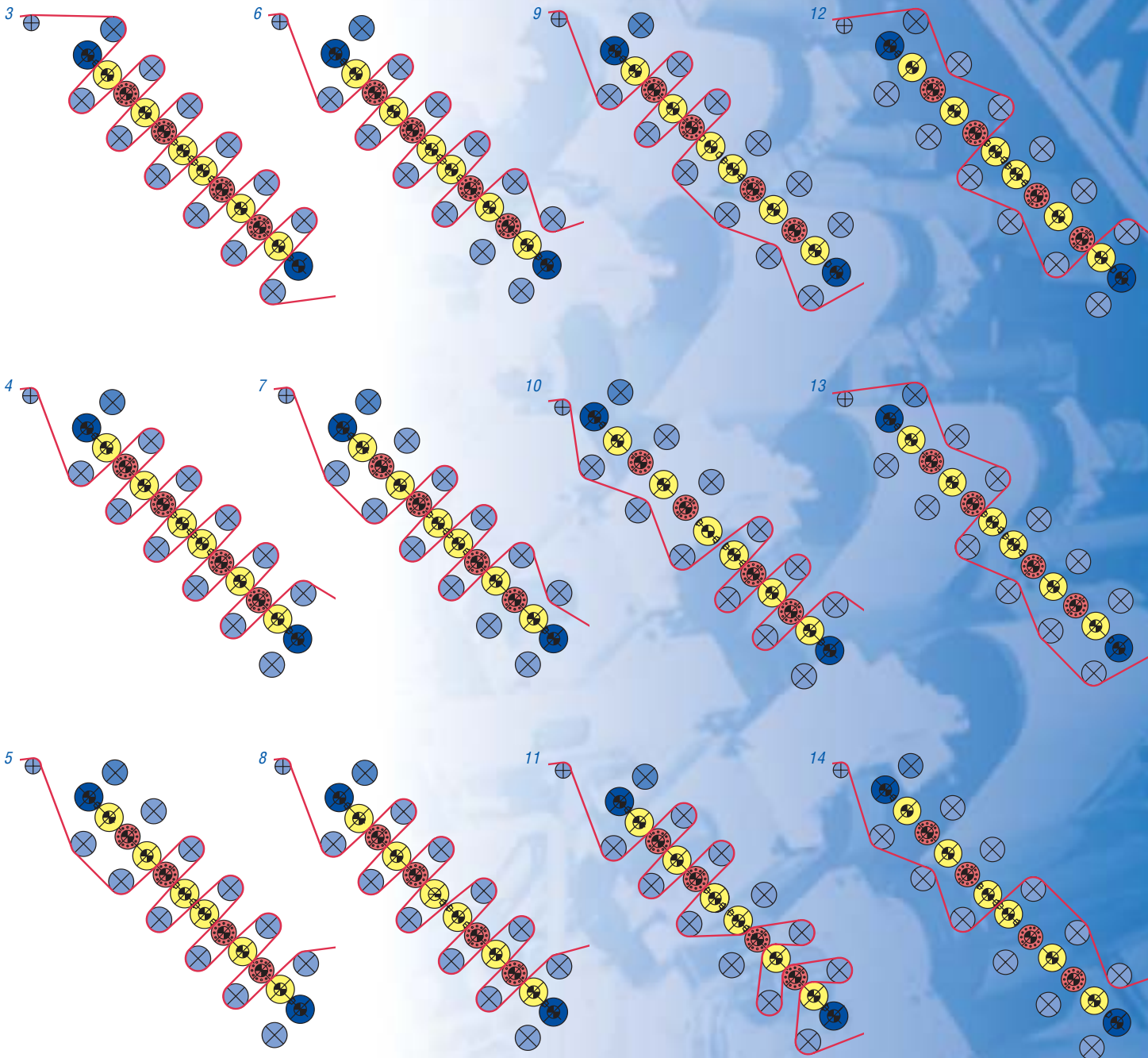

Figs. 15 and 16: roll changing.

Fig. 17: Roll accessibility.

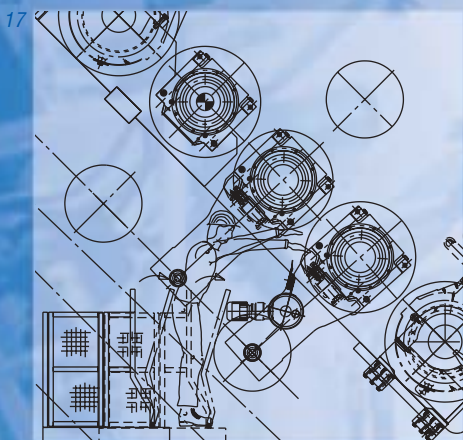
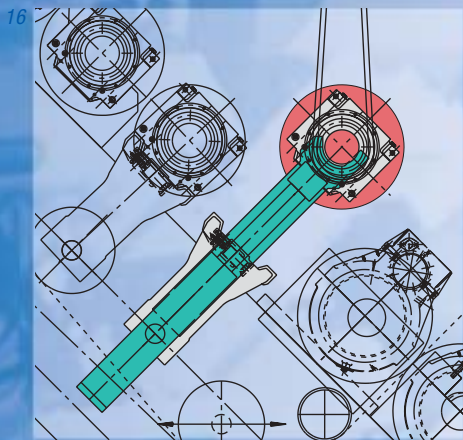
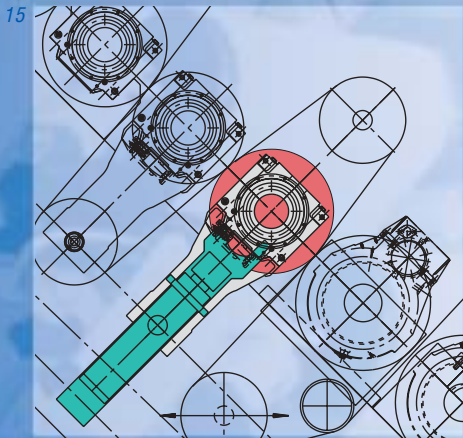

(Fig. 17). Thanks to the 45° layout, the drive aggregates are also more easily accessible – as against wide calenders with vertical layout, where distances are too big for direct access.

Optimal temperature/humidity conditions

The Janus MK 2 roll stack fits perfectly into the natural web run from the dry section through the calender. Thanks to more efficient venting, there is no build-up of heat or humidity. As a result, thermal loading on the plastic roll covers is reduced and the web loses less moisture and heat. Another advantage is the reduction of the web length by approx. 11.5 meters when using a Janus MK 2 with two sets of 5 rolls in one stack instead of a vertical Janus calender with two single stacks. This also reduces the unwanted loss of moisture. The outcome of these advantages are more consistent calendering results.

Direct production flow

Furthermore the Janus MK 2 design enables a more linear paper run. This reduces the amount of sheet guiding and tail threading equipment otherwise required, including maintenance expenditure.

Automated tail threading

All online calenders have a fully automated tail threading system for every sheet guiding layout required. This system, comprising vacuum belts and sheet

threading ropes, is extremely reliable over the entire range of operating speeds, thus contributing decisively to minimizing production outages. On our calender test facility, the tail threading procedure can be simulated in online calendering mode (Fig. 18). After conducting tests for adapting the tail threading system to individual customer needs, acceptance trials are carried out to demonstrate system effectiveness.

Conversion procedure

Work on upgrading the original Janus into a Janus MK 2 calender commenced in mid September 1998. All the new calender components were rapidly developed and implemented in teamwork by more than a dozen engineers and technicians. To minimize costs, as many existing Janus components as possible were reutilized. It took some time until the team got accustomed to working at 45°! Dismantling work on the “old” Janus started in the last week of October 1998. Two enormous demolition machines first spent the whole week tearing up the foundations and enlarging the calender pit – a nerve-wracking time for all our R&D people in Krefeld. After completing the civil engineering work, installation of the first Janus MK 2 started on December 7. Unfortunately the schedule was delayed by manufacturing bottlenecks, due to simultaneous processing of four calender orders. Nevertheless, we still got our Christmas present in time – Santa Claus,

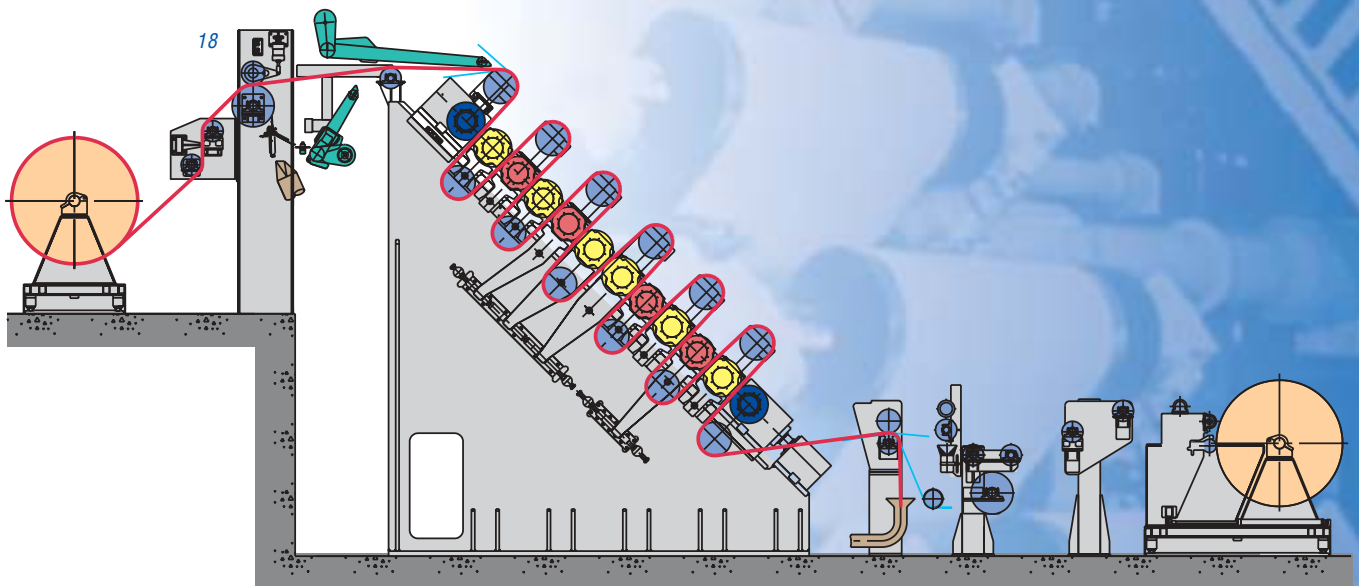

Fig. 18: Tail threading system on the calender test facility.

in the shape of a mobile crane, delivered the new roll frames through a small shop roof opening. Twenty erectors then worked double shifts until the calender was finally commissioned in mid February 1999. Dealing with the new layout also required a lot of rethinking and learning. On April 8 this year customer tests were carried out for the first time with the new Janus MK 2, after the successful completion of our own test runs. And now our calender test facility is booked out for months ahead, thanks to the enormous interest of the paper industry in this new concept.

Summary and outlook

All the future prospects which had previously been theory have now been con-

firmed in practice with our new Janus MK 2 calender. Customer acceptance of the MK 2 concept is impressively shown by three orders already received before the new test facility was even completed.

Technical data of the Janus MK 2 calender test facility

■ Operating modes:

- 12 calendering areas
- Online tail threading simulation up to 2,000 m/min
- Rewinding

■ Line force ranges:

- Janus mode with 1 x 12 rolls: 51-500 N/mm
- Janus mode with 2 x 5 rolls: 40-500 N/mm
- Duo/single nip mode: 25-250 N/mm
- Matt nip mode: 5-350 N/mm

■ Max. operating speed: 1,500 m/min

■ Web width: optionally 800 mm or 640 mm

■ Max. winding/rewinding diameter: 1,200 mm

■ Reel core diameter: optionally 106 mm or 150 mm

■ Max. heating roll surface temperature: 150°C

■ Max. steam heating temperature: 200°C

■ Heating roll coating material: Sume*cal

■ Roll type: Nipco

■ 7 steam showers installable at each nip intake for sheet humidification on one or both sides

■ Edge trimming

■ Cooling roll

■ Sensomat Plus centre winder.

Finishing Division:

Twister goes American – innovative roll wrapping in practice



The author:
Thomas Lücke,
Finishing Division

The new paper roll wrapping concept

In order to meet new printing market demands, Madison Paper Industries (Maine, USA) decided to change their production parameters. A wider range of paper roll sizes was required, extending in future from 374 mm (14.75") to 3,810 mm (150") across.

Their conventional wrapping machine could not handle such sizes. A larger extension of the existing building was impossible due to space limitations. The only solution was to install a completely new wrapping machine requiring only a minimum of space thus allowing to keep the extension of the building within limits.

All requirements were ideally met by the Twister, moreover the spiral wrapping concept had proved itself well at the Myllykoski Corporation's Lang Papier GmbH mill in Ettringen, where a Twister was already working with good success. In connection with the new wrapping machine, Voith Sulzer Finishing also received the order for an associated roll transport system.

The Twister principle for optimal roll wrapping

A brief presentation of the Twister working principle may be useful. It was developed to cover the increasingly wide range of paper roll sizes now being produced,

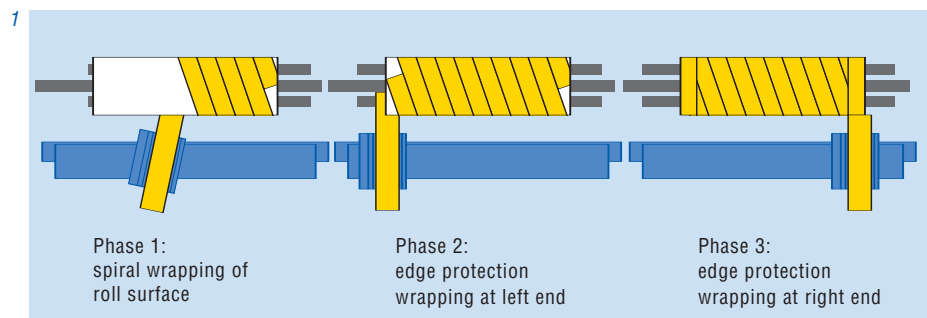

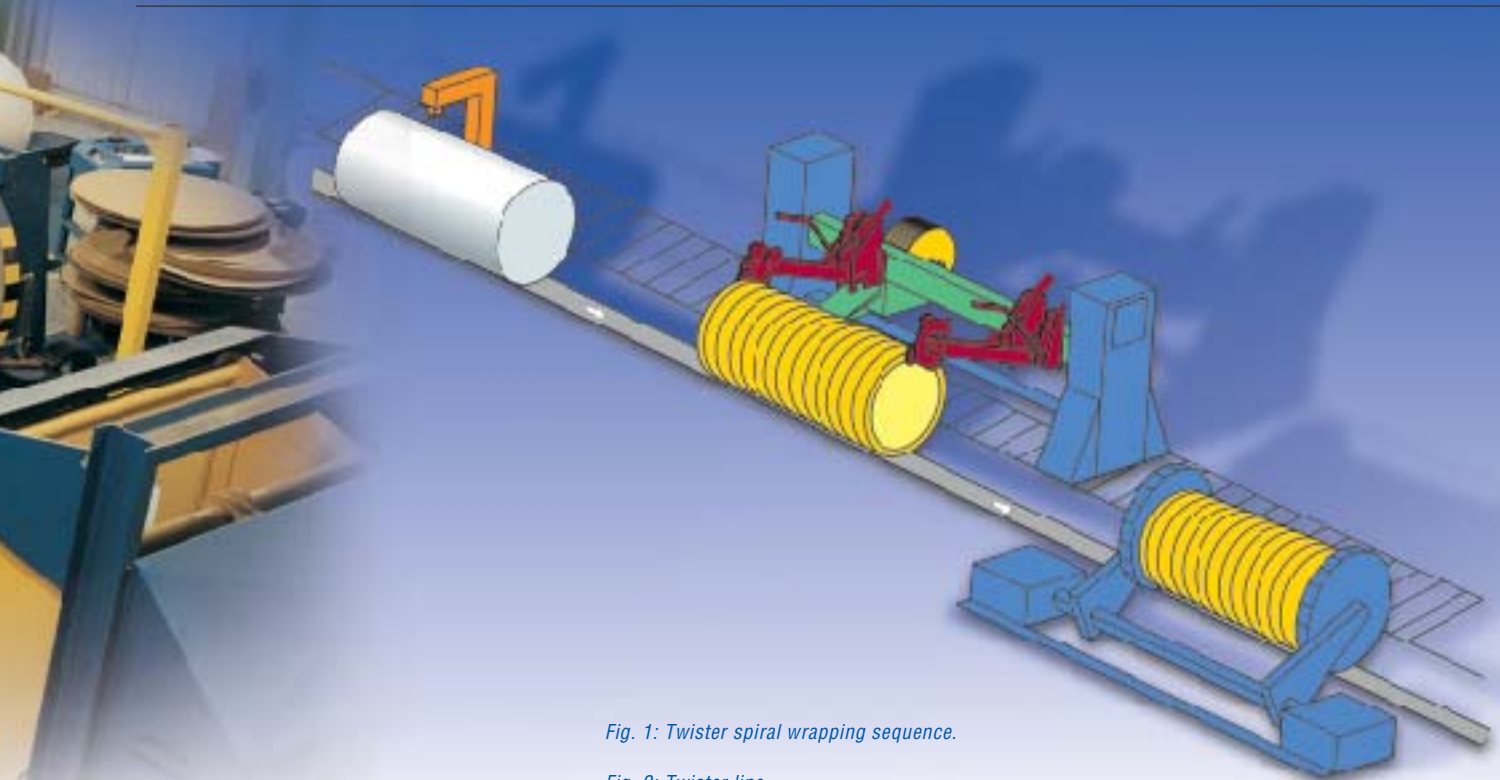

Fig. 1: Twister spiral wrapping sequence.

Fig. 2: Twister line.

2

which demands greater wrapping machine flexibility.

Due to more frequent roll size changes, from the narrowest to the widest, the number of unwind stations for packaging paper rolls is high on conventional wrapping machines.

For each roll width a packaging paper roll of the same size is required, plus a minimum overlap of 100 to 250 mm for edge wrapping.

This requirement makes conventional wrapping machines complex and therefore expensive. This is the reason why Voith Sulzer Finishing developed a new roll wrapping concept which uses only one standard packaging paper format for paper rolls of any width and diameter.

This development led to the Twister concept, which works on the spiral wrapping principle.

Only one packaging paper width of 500 mm is used for all roll sizes. The wrapping angle and resultant feed speed along the roll axis is adjusted according to the number of wrapping layers required. To ensure good climatic sealing and wrapping stability, each overlapping layer is glued.

At both ends of the roll an additional overlap of 150 mm can be wound to protect the roll edges and end faces. Any number of edge protection layers is possible. Fig. 1 shows the spiral wrapping sequence of the Twister followed by edge protection wrapping.

Twister wrapping is complemented with inner header disks inserted prior to end wrapping, and PE-coated outer end header disks pressed against the roll faces by a heated header press.

To cope with the wide variety of wrapping requirements in the paper industry, the Twister design is modular. This enables

optimal wrapping for each application by modifying the roll handling system layout accordingly.

- The most compact Twister layout is the **Combi** machine. At a single station, the entire wrapping operation is carried out. The paper roll is transferred to the Twister from the transport system, and automatically ejected again after wrapping. This machine can handle up to 25 rolls per hour.
- Another Twister development is the **Center** type. With this type, the outer header disks are no longer applied in the wrapping/crimping station itself, but in a separate press station so that the wrapping/crimping action and the action of applying the outer header disks can be carried out simultaneously. This increases the capacity to about 40 rolls per hour.
- The third type of Twister is the **line** layout. All wrapping stations are

Fig. 3: Packaging line layout.

Fig. 4: Control levels.

Fig. 5: Control concept.

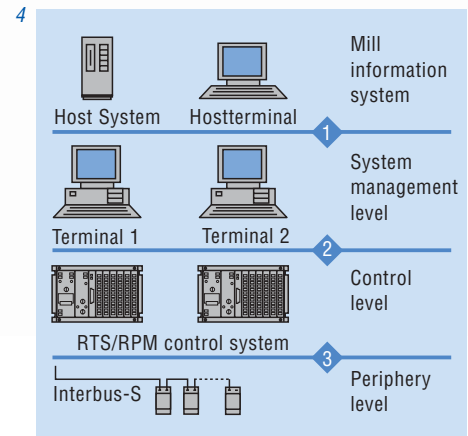
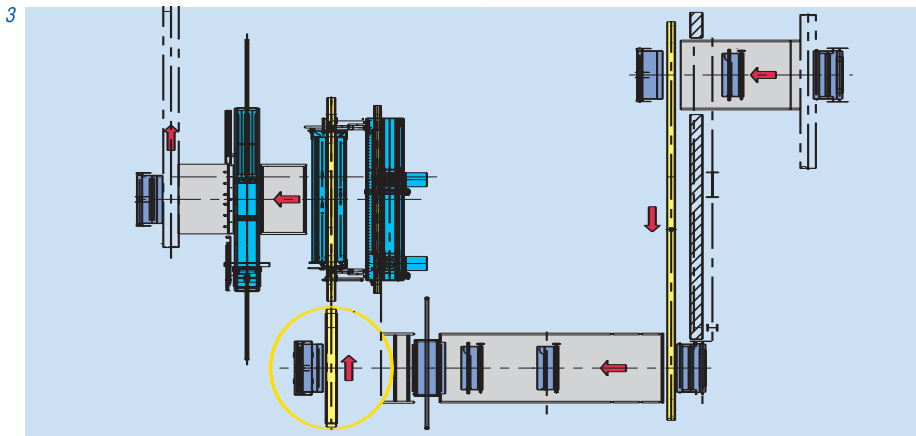

arranged linearly, without any additional roll ejections or insertions. Fig. 2 shows a Twister line layout, where spiral surface wrapping and edge wrapping can either be done at a single station or at 2 stations in line.

Each Twister version can incorporate one, two or (with the line layout) even three wrapping sequences. Edge wrapping is taken over by the second or third wrapping operations without requiring any angular adjustment.

These different types of Twister are rounded off with peripheral handling equipment for the inner header disks, outer header disks, labelling and inkjet coding. Various degrees of automation are available, with portal and/or robot systems. Together with automated handling of the inner and outer header disks, up to 120 rolls per hour can be handled with the Twister 3 Line automated version.

Project handling

The entire Madison project, from receipt of order to Twister acceptance testing including roll transport system, was coordinated by three teams. Site coordination was handled by the Madison team, Voith Sulzer Paper Technology Middletown coordinated with the customer, and project implementation was handled by Voith Sulzer Finishing in Krefeld.

The overall plant layout is shown in Fig. 3.

System operation

Paper rolls for packaging, barcoded on one end, are transferred by existing conveyor to the Voith Sulzer Finishing roll transport system. They are then positioned for Twister packaging via ejectors, sloping ramps with overrunable bumpers slat conveyors and a turntable.

During transfer, all packaging data are recorded – roll diameter, width, weight,

and the scanned-in roll number – and coded by inkjet on the end of each roll. The roll width data is used for correct positioning in the Twister, so that the spiral wrapping procedure can begin without delay.

After wrapping the inner header disks are inserted manually and fixed by a robot arm. Then the edges are wrapped at each end in turn. During this procedure the crimping arms move into position. Their crimping wheels swivel against the roll face to fold in the edge wrapping overlap.

Thereafter the roll is stopped ejected and between the press plates. In the meantime, the next roll has already been positioned ready for wrapping in the Twister. At a temperature of 200°C, the heated press plates fit the outer header disks and apply the final seal.

After manual labelling, the packaged rolls

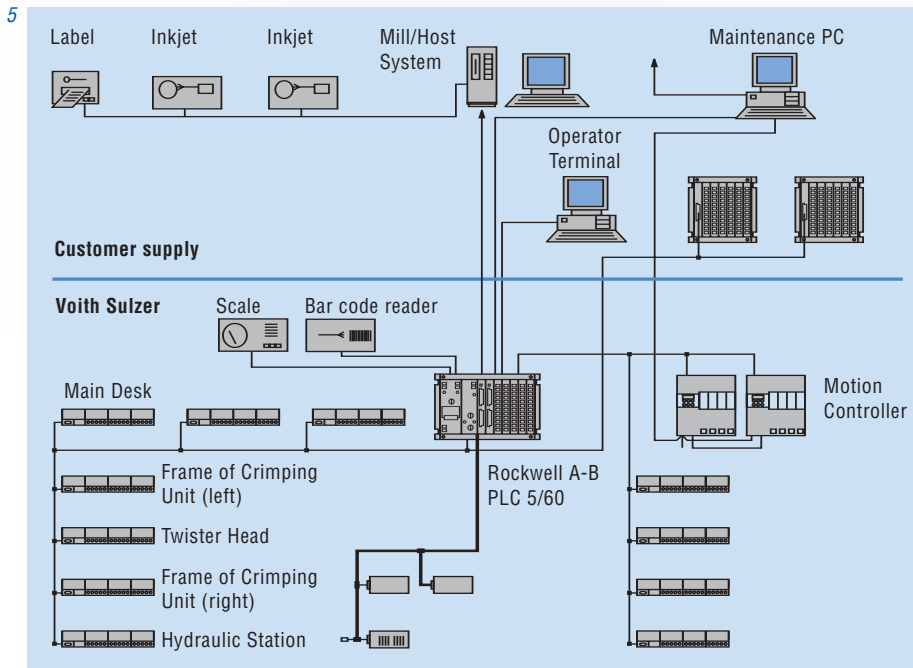
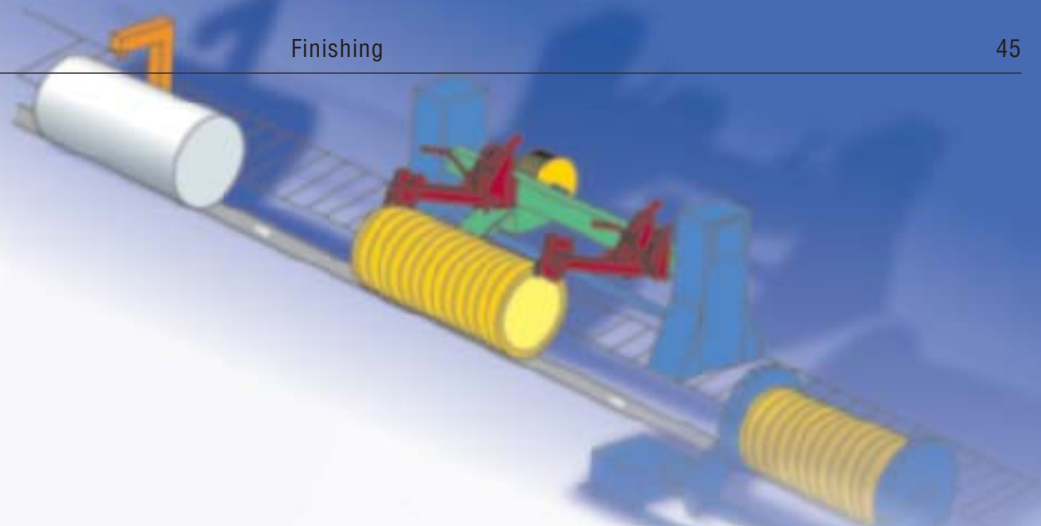

Bradley SPS control and drive technology in the Twister as a new development for the US market. The associated development work for this Twister project was carried out jointly with Madison.

The new drive system developed for the American market incorporates completely different components and data interchange procedures (Fig. 5).

While a standard Twister drive gear concept is still used, all servodrives are supplied by Rockwell/Allen Bradley. The 8 servodrives are divided into two motion control system groups of four each, with capacity equalization as far as possible. Contrary to the standard Twister concept, data interchange between the two motion control systems is direct.

of paper are then returned to the customer's transport system for delivery.

Control system and drive concept

The control concept of the Voith Sulzer Finishing transport and wrapping system combines SPS machine controls with the user-friendly Rolltronic visualization and control system.

For greater transparency, the control system is divided into four levels (see Fig. 4).

The 4 levels are interconnected either serially or by databus, using various standard interfaces and bus systems as appropriate.

A standard drive concept is used for the Twister, basically comprising 8 Lenze servodrives each connected via a separate controller to a Siemens S7 SPS data interface. This handles all data interchange between the individual controllers. An addition to the servodrives, frequency-controlled drives are also provided for auxiliary functions, such as the two edge overlap folders, or the slat conveyor for inserting rolls into the Twister.

To ensure troublefree local spare parts supplies and service, Madison required a control system and drive concept using Rockwell/Allen Bradley components easily available in the USA. Voith Sulzer Finishing therefore incorporated Allen

Instead of the Siemens S7 control system normally used, a Rockwell/Allen Bradley PLC 5 controller is applied. Data interchange between the Allen Bradley PLC and the two motion control systems is via a remote-controlled input/output system. In line with the standard Twister concept, the control system periphery is decentralized and connected to the PLC.

Local control of the Twister system was programmed by Madison on one of their personal computers. Data communications between the Twister PLC 5 and the customer's PC are via a conventional network using standard protocol. This is

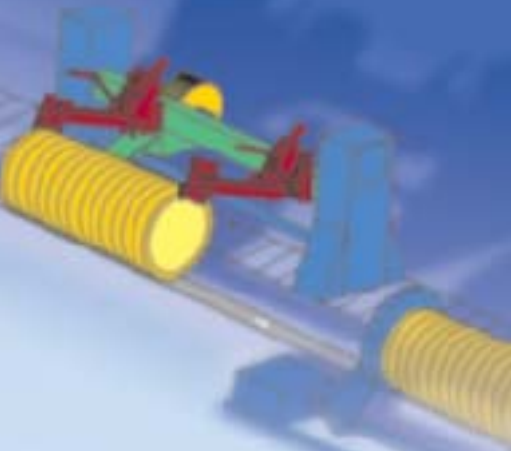

Technical data

This roll transport and Twister wrapping line was designed for the following production and performance data:

Paper roll dimensions

Roll width

min. 374 mm (14.75")

max. 3,810 mm (150")

Roll diameter

min. 812 mm (32")

max. 1,524 mm (60")

Roll weight

max. 6,100 kg (13,240 lbs)

Admissible width/diameter ratio

min. 1:3

Packaging paper

Roll width 500 mm (19.70")

Diameter max. 1,500 mm (59")

Inside core diameter 150 mm (6")

Fold overlap each side 150 mm (6")

Number of spiral wrapping layers 2-4

Roll wrapping machine capacity

■ with paper roll diameter 1,093 mm (43")

■ with 2 layers of spiral wrapping

■ with 1 operator per shift

■ with paper roll width up to 1,776 mm (70")

40 rolls/hour = 720 rolls per day
(working time 18 hours)

used for feeding data such as roll weight and barcode No. to the customer's PC system, which then prints out labels and inkjet coding.

A significant difference between the standard Twister layout and the Allen Bradley version is that SPS control functions are taken over by the motion control systems.

Installation and commissioning

In parallel to development work on the new control and drive concept, structural preparations and installation of the roll transport and wrapping systems was completed on schedule. The Twister and transport system components were installed on the first-floor structural steelwork in the new roll wrapping hall.

While hall construction continued, all the mechanical and electrical Twister installation and wiring work was completed within 9 weeks. After electrical input/output testing, commissioning of the new Allen Bradley control and drive system started.

Various teething troubles arose in this connection, but they were all solved when Madison agreed to use our well-proven stepped programming procedure.

Another problem was inadequate time for drive system optimization tests in our works. This particularly applied to the

comprehensive synchronization of all motions, such as spiral wrapping speed and feed, edge wrapping and crimping.

Commissioning was nevertheless completed by the end of 1998, and the system was then released for operator training and further optimization.

Summary

In this particular case, the basic principle of using standard components could only be upheld with regard to mechanical parts. For the system layout, Voith Sulzer Finishing used well-proven standard modules. For the control and drive concept, standard components could not be used due to US market requirements.

For this reason, Voith Sulzer Finishing has developed a completely new control/drive system not only for this case, but for all future needs on the US market.

It goes without saying that with new developments such as this drive/control concept, teething troubles were unavoidable. Thanks to excellent cooperation with Madison and Allen Bradley, all problems were solved efficiently.

How to prevent tiger stripes



Pronounced stripes on kraftliner on a currently operating paper machine.

Kraftliner, on the right: with standard diffusor block, on the left: with new diffusor block, all other conditions are the same.



The author: Dr. Walter Holzer, Paper Machinery Division Board and Packaging

Until recently, the wire side of numerous packaging paper grades showed more or less irregular stripes when the light fell at a certain angle onto the paper sheet. In American language, these stripes are often referred to as “tiger stripes”. The appearance and intensity of the stripes often was very different – they varied from fine stripes to a clouded appearance, from almost invisible to highly conspicuous. The stripes are typically about 100-300 mm long and 5-35 mm wide (*Fig. on the left*). The gloss effect largely depends on the angle at which the light falls onto the paper. It is diminished if

one looks at the stripes with one eye only. In reality, it is more intensive than in photographs.

Papermakers are very familiar with this phenomenon – particularly in connection with the production of papers with low Schopper-Riegler on the fourdrinier. Optimizations in the area of the wet section lead to a reduction of the stripes but hardly ever to a complete elimination. Tiger stripes are very pronounced at large lip openings > 20 mm of the fourdrinier headbox and when long fiber pulp and/or CTMP is used.

Especially on packaging papers, such as testliner and linerboard, the wire side is the printed surface where the stripes may significantly impair the printing appearance. Pronounced narrow stripes (worms) may, in addition, cause waviness in the paper and, thus, impair printability and sheet flatness.

For about one year, the question has repeatedly been raised to what extent tiger stripes could be reduced or prevented on existing paper machines. Specifications of new machines increasingly demanded to prevent stripes or at least keep them inconspicuous. For this reason, numer-

ous tests have been made on the VPM 5 pilot paper machine, in Ravensburg, since autumn 1997. In intensive cooperation with customers, various test series were performed to examine how such stripes can be prevented. Different nozzle shapes and installations in the headbox nozzle were examined, using kraftliner as an example, based on the knowledge gained so far in this area and the experience with graphic paper machines.

The breakthrough was achieved in January 1999 – perfect results were reached with a novel diffusor block for the headbox of the VPM5, with which almost all specific throughputs that are of interest – from about 2,500 to 18,000 l/min*m – can be tested. A patent application for the diffusor block has been filed. Following the tests with kraftliner in January 1999, the best configuration was also tested successfully on white stock (bleached CTMP).

The results were so convincing that the customers involved in the development work pushed for swift installation in their plants. Implementation in practical applications, taking into account runability and easy maintenance, are at the point of completion.

Research and Development:

The significance of response function width and mapping quality for control system performance



*The authors:
Rudolf Münch, Ulrich Begemann,
Paper Machinery Division Graphic*

Cross-profile quality control factors which are often neglected

Headbox cross-profile control performance depends not only on actuators spacing, but also very much on the response function width of each control element. The mapping precision of actuators over the web is likewise extremely important.

The main mechanisms involved are explained here taking two consistency-controlled headboxes as an example.

Response function width

The performance of consistency-controlled headboxes is often linked only to

the actuator spacing, i.e. the valve spacing. This can lead to erroneous conclusions, because from the practical point of view, response function width is much more important than control element spacing.

For example, a headbox with a actuator spacing of 64 mm and a response function width of 105 mm (corresponding to a widening factor of 1.64) generates better cross-profiles than a headbox with 35 mm spacing and 130 mm width (widening factor 3.7). Why?

As shown in *Fig. 1* (especially zones 2, 3, 4), the greater the widening factor of a control element, the more the neighbouring elements are cancelled out. The result of the overlapping response functions are closely spaced basis weight fluctuations of very low amplitude. This leads to the following conclusions:

- CD control of closely spaced profile deviations is practically impossible with large widening factors.
- If the attempt is nevertheless made, the result is an extremely large actuator movements with little effect on paper quality. This greatly reduces adjustment potential, so that quality deviations with wider spacing can only be reduced by the controller to a limited extent. These useless actuator movements are counteracted in systems with large widening factors by

filtering out closely spaced CD deviations. Adjustment potential is thus restored, but no benefit is derived from the closely spaced actuators.

Fig. 1 also shows that in case of a saw-tooth pattern of the control elements with absolutely identical response functions and equally spaced maxima, basis weight changes in the paper are theoretically very slight. In practice, neither of these conditions is exactly fulfilled. Due to the high intervention amplitude, extreme basis weight peaking occurs even with only slight deviations from these ideal conditions. The risk of "striping" therefore increases with the control element widening factor.

Another important requirement is that different control elements must have a uniform response function width. If the response function width changes as a function of feed rate, for example due to hydraulic effects at the whitewater feed point, the control algorithm should theoretically include a separate response characteristic for each valve opening and each headbox throughput. It goes without saying that this is completely impracticable.

If a actuator response function width changes according to intervention amplitude, cross-profile streaks will be generated when controlling closely spaced basis weight deviations.

Fig. 1: Control system behaviour with a large valve response widening factor. Response function width = 3.3 x control element spacing. Individual responses Superimposed responses

Fig. 2: Profile improvement as a function of mapping error.

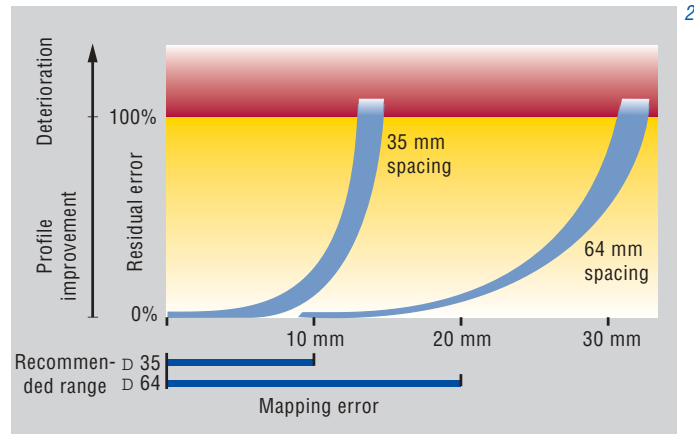
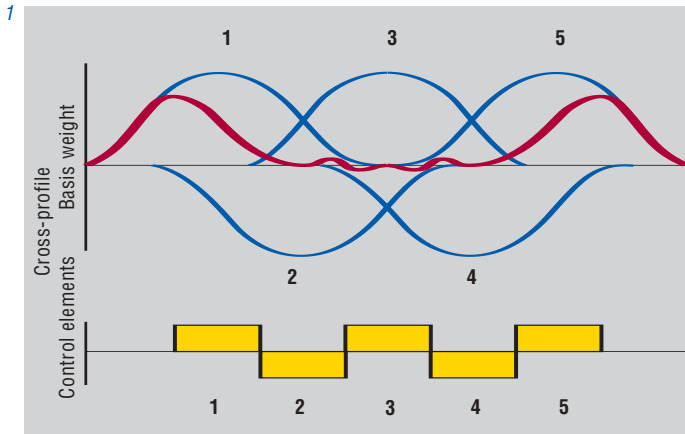

Mapping quality

As explained above, a small response width is not necessarily beneficial. But even a headbox with 35 mm spacing and 90 mm response width gives no better results than one with 64 mm spacing and 105 mm response width.

This is because another decisive factor influencing control system performance is signal quality, not only the control element itself.

If the absolute mapping quality – the precise correspondance between the CD position of control elements and the CD position of the response function on the paper – is not adapted to the smaller spacing, relative mapping error will increase and control system performance will deteriorate accordingly. The profile improvement potential of a control system depends not on the absolute mapping error, but on the relative error as a function of actuator spacing.

Fig. 2 shows residual cross-profile error for two different actuator spacings as a function of absolute mapping error. With a mapping error of 30% relative to actuator spacing, system stability deteriorates so significantly that profile improvement is only very limited thereafter. And with a relative mapping error of 50% or more, the profile is worsened rather than improved.

Based on the above findings, the admissible mapping error is about 10 mm for a actuator spacing of 35 mm, and 19 mm for a spacing of 64 mm.

Since the standard cross-profile measuring spot size is about 15 mm today, mapping precision can hardly be improved beyond 10 mm. Furthermore, mapping precision is particularly limited due to factors such as web run fluctuations. In order to avoid sawtooth effects with such small control element spac-

ings, several control elements must be coupled together. This means that adjacent valves have to be actuated simultaneously. This eliminates the possibility of controlling closely spaced CD deviations. In the end, closely spaced actuators only bring drawbacks such as greater risk of contamination and greater maintenance outlay.

Even with a control element spacing of 64 mm, achieving the required mapping quality of about 19 mm is a very demanding task. Clearly, a mapping precision of 19 mm can never be attained by carrying out conventional bump tests from time to time. In order to fully exploit the advantages of sophisticated stock consistency control systems, on-line mapping identification must therefore be incorporated in the control algorithm as a mandatory requirement.



Voith Sulzer Paper Technology and Fibron – together and proud of it!



*The author:
Elisabeth Rooney,
Fibron Machine Corporation,
Vancouver, Canada.*

On January 1st, 1998 Fibron Machine Corp. was purchased by Voith Sulzer Paper Technology. Fibron forms the nucleus for the development and marketing of sheet handling technology. Fibron's initial focus was on full machine threading solutions, and is now expanding to coordinate threading with other related sheet handling technologies that concentrate on improving overall machine efficiency and run-ability for both new and existing paper machines.

Because Fibron is accepted worldwide as the leader in developing effective threading technology, the new company has retained the original name, trademark and logo. The original staff members, headed by Steve and Ken Rooney, and Allan Broom have also been retained, assuring continuity for both existing and new customers.

Hans Peter Sollinger, President of Fibron and Voith Sulzer Paper Technology executive, explained the merger goals as follows. Fibron will be maintained as an independent entity within the global paper industry and will continue to be a full service supplier of comprehensive threading solutions not only to Voith Sulzer, but to all customers. Priority will be given to providing the very best threading technology and services wherever they are needed.

First known as the Durand system, Fibron was founded in 1984 in Vancouver, Canada to focus exclusively on threading. This family owned company achieved worldwide acclaim by developing the unique Fibron vacuum tail trans-

fer (VTT) system, and for redefining "acceptable threading". Fibron is responsible for bringing to the industry's attention the substantial negative effect that inefficient or unsafe threading can have on total machine operations.

In addition, Fibron also brought to the paper industry an innovative marketing style. Using computer based programming, the system is easily tailored to individual requirements so that each customer receives a detailed and highly interactive, custom presentation. The effective use of this technology permits presentations that are easily accepted and understood by customers around the world. Using animations, video clips, drawings, photographs and text, the benefits of each solution proposed are easily demonstrated.

Fibron Experience

More than 4,500 Fibron VTT units are currently in operation worldwide. This well-proven system handles applications from the wet end to the dry end, at machine speeds ranging from 35 m/min to 2,200 m/min, on grades from 8 g/m² tissue to 850 g/m² board and pulp.

The Fibron System – how it works

The most important component of the Fibron VTT System is the conveyor, which transfers the tail by moving a porous belt running at machine speed over a vacuum box. This combination of moving belting and vacuum allows the VTT conveyor to maintain complete control of the tail during threading. It also permits vertical and inverted transfers with virtually no slack. Serrated rippers and choppers automatically eliminate the

Fig. 1: Vancouver, Canada – the home of Fibron.

Fig. 2: Overview of tail threading systems.

Fig. 3: Wet-section threading.

Fig. 4: Threading an EcoSoft calender.

Fig. 5: Calender threading.

Fig. 6: Janus concept threading.

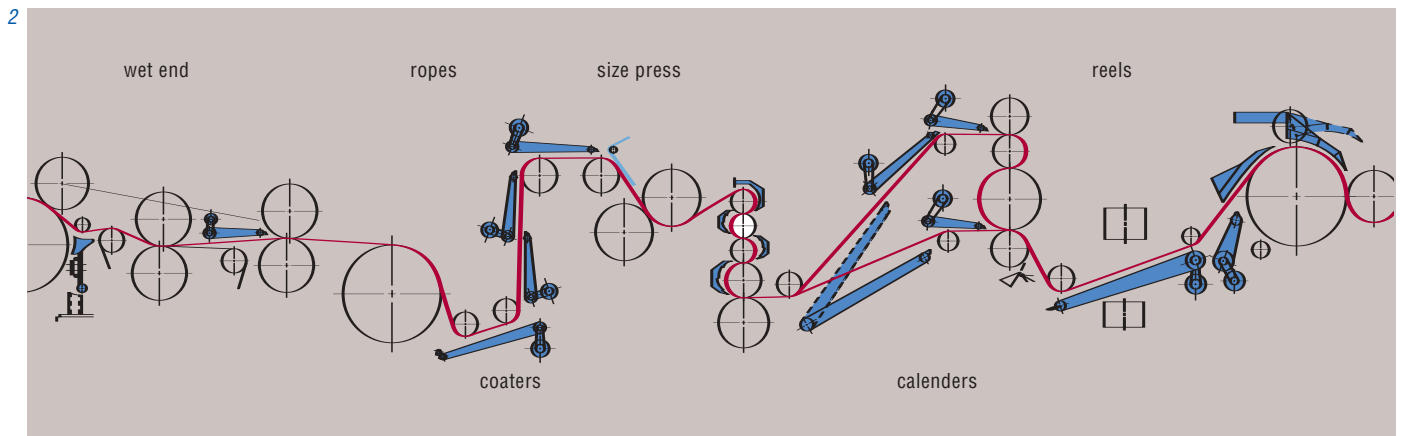

double tail. The system is remotely operated to keep operators out of high risk nip areas during threading. VTT systems automatically match varying machine speed and grade requirements without operator adjustments.

A variety of accessory equipment enhances the operation of the VTT conveyor.

Mini Doctors are used for separating the tail from a roll to start the threading process when machine configuration does not allow for direct mounting of a transfer device on the main doctor.

Special jets and trays are used as required for stabilizing and directing the tail.

Rippers and choppers are available in various versions to reliably eliminate double tail at the start of the threading process.

Deflectors are used for supporting the tail and changing its direction between conveyors or in spaces too constricted to install a conveyor. Deflectors can also be used to achieve dual position reel threading.

Calender threading shoes are used for threading intermediate nips in the calender stack without operator intervention.

P&T and L&T Shoes with specialized non-contacting air doctors and deflectors, are installed in the wet end to reliably transfer the tail in constricted wet end spaces.

New generation conveyors: VTT 2

The latest generation of VTT conveyors (VTT 2) was unveiled at Exfor 99 in Montreal. This new conveyor is based on the original vacuum box concept, but is smaller, more compact and much easier to service. It can also be used at operating speeds up to 3,000 m/min and temperatures up to 120°C.

More research and development

Fibron is carrying out extensive R&D work on threading technology innovations as well as improving existing systems. This includes rope system design, tray systems and ropeless dryer threading. With the introduction of TEAMS™ (Threading Evaluation And Managed Solutions), Fibron offers customers a comprehensive approach to overall threading system design. Following a detailed machine audit, recommendations integrate all appropriate threading technologies to give the customer the most efficient, cost effective solution that does not compromise long term performance.

Integrating threading early in the design process

Both Fibron and Voith Sulzer have long recognized the importance of integrating the threading system early in the design stage of a project, especially on high speed, complex projects. How well the early integration of threading into the design process pays off is illustrated by two outstanding projects – the world's first online Janus calender project at Lang Papier, Ettringen, and the highly successful installation and startup at Sappi Europe, Gratkorn, Austria.

Figs. 7 to 9: Loss of production and annual revenue due to inefficient threading.

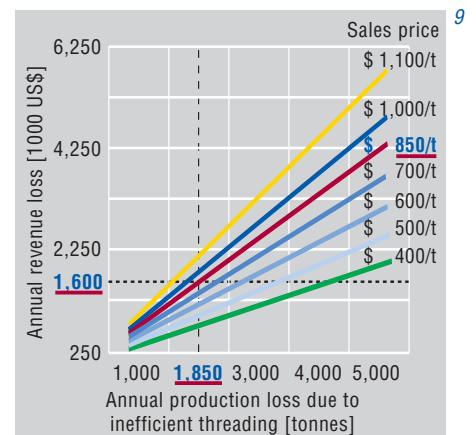
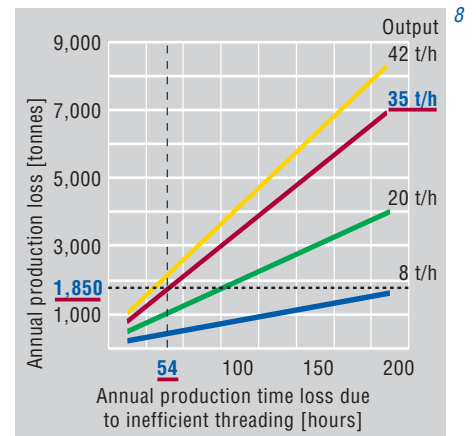
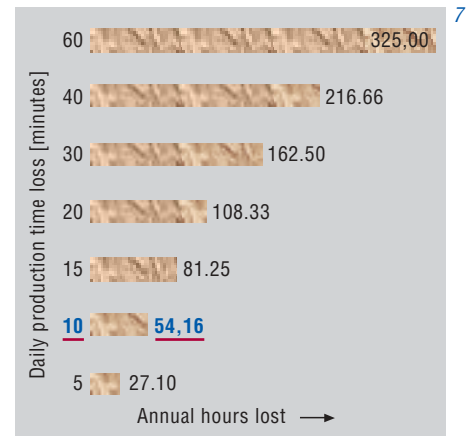

Fig. 10: Demonstration unit.

Why is threading important?

When threading is properly managed and designed as an integrated system, operator safety can be significantly improved as well as overall machine efficiency and production. At the same time, manufacturing costs and machine complexity are reduced. On the other hand, a threading system that takes longer to thread each day than a more efficient, safer system can easily cost the mill more in lost production in one year, than the cost of a better system.

To illustrate this point, we will use the example of a paper machine operating 325 day p.a. (about 89% efficiency), producing 35 tons/hr of fine paper, at a selling price of US\$ 850.00.

As shown in Fig. 7, 10 minutes of lost production per day due to inefficient threading adds up to 54 hours lost per year. At 35 tons per hour, this is 1,890 tonnes of lost production annually (Fig. 8). This results in US\$ 1.6 million of lost revenue each year (Fig. 9).

A more efficient threading system which threads in half the time can easily pay for itself on the basis of increased production alone.

If included in the initial design phase of a project, a safe, efficient and cost effective threading solution can be developed which offers long term benefits for the customer without compromising machine efficiency or product quality.

Training and information

In the autumn of 1998, Voith Sulzer Paper Technology started setting up a threading technology training and information centre in Heidenheim. Using modern multi-media techniques and a fully operational demonstration unit (Fig. 10), in-depth seminars are held here. Customer personnel learn the importance of threading, how current threading technologies and new concepts can be applied effectively to their specific operations, and how improved sheet handling can save time and money.

Proud to be part of the team!

Fibron is proud to be part of the Voith Sulzer Paper Technology team, working with all partners toward even greater long term threading efficiency for VSPT's state-of-the-art technology.



Concentrated deinking know-how

The 8th international symposium of “Deinkers” organized every two years by the Papiertechnische Stiftung (PTS) Munich took place for the first time together with the French paper research institute Centre Technique du Papier (CTP) Grenoble.

As the leading deinking systems supplier, Voith Sulzer Stock Preparation was present with several papers. In addition to two own contributions, the Stock Preparation Division was also co-author of two joint papers together with the Institut für Papierfabrikation at the Technical University of Darmstadt and with the Austrian paper mill SCA Laakirchen AG. The joint papers presented the results of cooperation work.

The following summarizes the main points of the four papers.

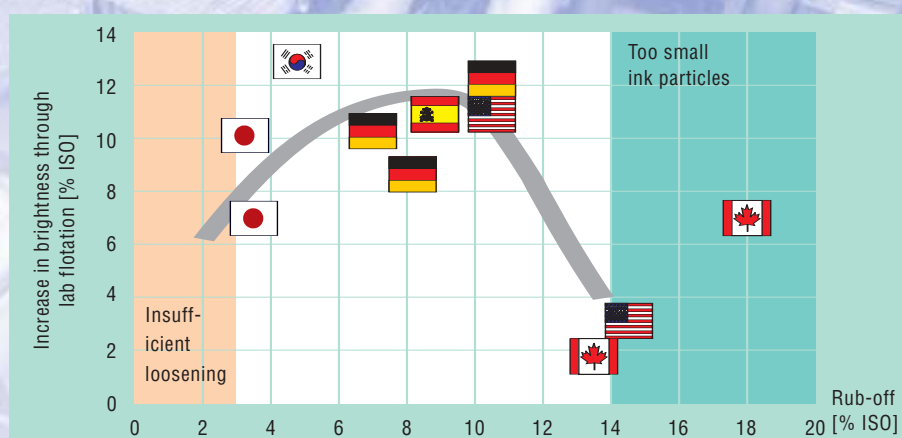

Studies on the Deinkability of Low Rub-Off Inks

Harald Selder, Jürgen Dočkal-Baur,
André Gäbel, Voith Sulzer
Stoffaufbereitung GmbH & Co. KG

Worldwide requirements on the rub-off resistance of printing inks vary widely. While daily newspapers in the United States have a high rub-off, newspapers in the Asian region have a very low rub-off value. The rub-off resistance of newspapers and magazines in Central Europe lies between these two extremes (Fig. 1). Rub-off characteristics depend on the composition of the ink used. Ink producers have now added special low rub-off inks to their range of standard inks. In these special inks, part of the mineral oil has been replaced by oxidative-drying vegetable oils.

Studies of American, Asian and European daily newspapers have shown a good correlation between rub-off value and

deinkability. While American recovered newspaper furnishes are no problem to deink, it is much more difficult to deink Asian dailies with low rub-off inks and these require a more sophisticated process.

For this reason a special deinking process has become popular in Asia, known as “soaking tower technology”. This process was examined in Voith Sulzer Stock Preparation’s R&D Centre in Ravensburg, and compared with the 2-loop deinking technology used in Europe. Results of this comparison show that deinking is more efficient with the 2-loop process, and thus enables enhanced finished stock brightness.

Can Current Screening Systems for Stickies be Improved Still Further?

Dr. Samuel Schabel, Voith Sulzer
Stoffaufbereitung GmbH & Co. KG

The answer to this question is clearly

Fig. 1: Relationship of printing ink rub-off and increase in brightness through flotation.

Fig. 2: Visualization of flow conditions around a wedge wire screen basket profile.

Fig. 3: Simulation of flow through the accepts zone in a MultiSorter screen.

Fig. 4: Comparison of stickies removal using a single screen with two screens arranged in series at constant system rejects quantity.

yes. Nevertheless, the ways and means of further improving screening efficiency will change in future. While better results were achieved in the past mainly by reducing slot widths, in the future machines and systems will have to take account of more demanding quality requirements.

It is very important in this connection to identify the interactions between machines and systems, and take account of them in the machine development phase. This can only be done by using the latest R&D tools, such as flow visualization and the numerical simulation of flows and system behaviour (Figs. 2 and 3).

The operating characteristics of screening systems, for example as regards thickening, become increasingly non-linear with extremely narrow slot widths. For this reason, machines and systems with cascade feedback should be designed very carefully to achieve optimum and reliable screening results, despite fluctuating furnish qualities.

An appropriate system layout offering good potential for enhanced stickies removal comprises screening machines arranged in series – often known as an A-B layout. As shown in Fig. 4, this not only secures optimum product quality and cleanliness, but also optimum yield thanks to minimum fibre losses.

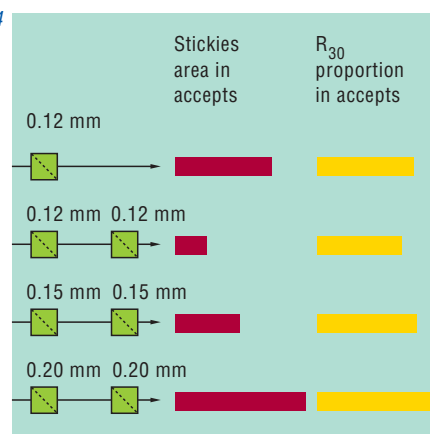
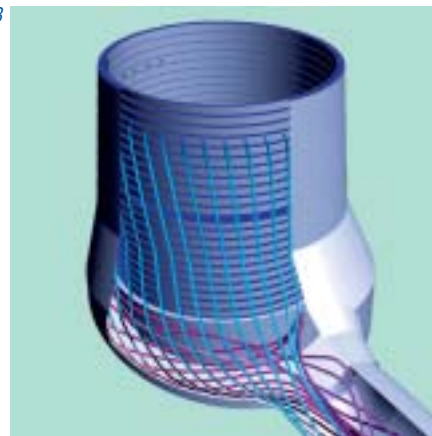
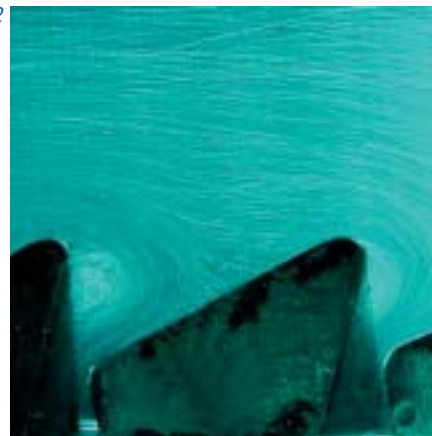

Neutral Deinking – Possibilities for Optimization

Dr. Christiane Ackermann,
Dr. Hans-Joachim Putz,
Technical University of Darmstadt;
Jürgen Dočkal-Baur, Harald Selder,
Voith Sulzer Stoffaufbereitung
GmbH & Co. KG

Alkaline conditions are still preferred in general for the deinking process, despite the associated drawbacks such as high costs of chemicals, additional organic effluent loading and greater stickies fragmentation. If alkalis are avoided, other additives must be used to ensure efficient removal of ink from the fibres. One possibility is to use appropriate tensides, although extensive laboratory testing has shown that their effects are limited.

On the other hand, modifying the mechanical pulping process and reducing consistency can give satisfactory results, at least in the laboratory.

Trials were carried out on this subject in the Voith Sulzer Stock Preparation R&D Centre with regard to detaching the inks from the fibres, ink removal by flotation, bleaching efficiency and stickies fragmentation. A system recommendation was worked out, based on the findings of a two-week test series. After pulping in the normal consistency range (around 15%) without alkali, the system incorporates a minimized Flotation I, dispersion with combined peroxide bleaching, and

Fig. 5: Optimized process for the preparation of recovered graphic papers.

Fig. 6: Increase in production capacity by rebuilding an E-Cell flotation plant into EcoCell design at SCA Laakirchen AG.

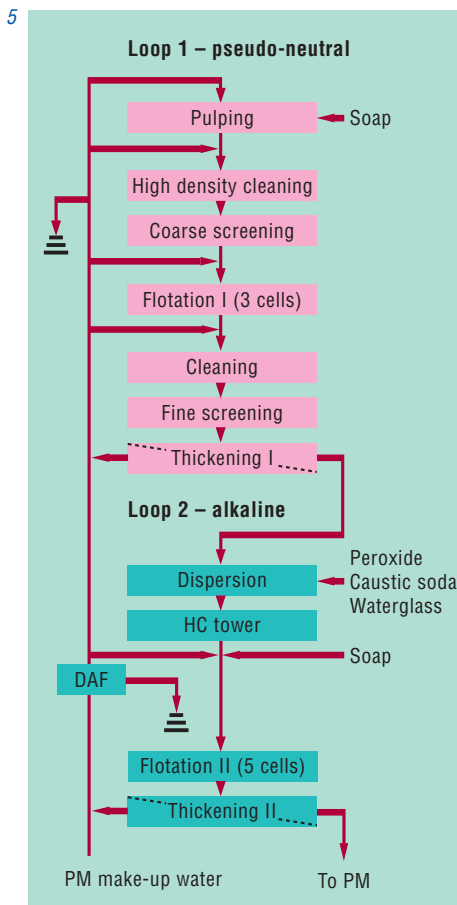

Flotation II with extended capacity (Fig. 5). By using water from the second loop, the first loop becomes slightly alkaline, too. This improves the detaching effect compared with a neutral milieu.

At the same time, the higher stickies fragmentation caused by alkalis is avoided. Coarse and fine screening, both integrated in the first loop, therefore result in a better stickies removal.

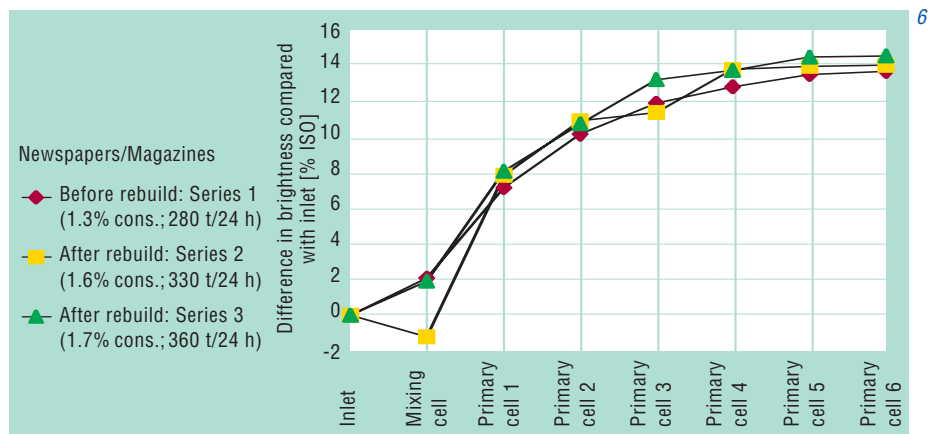

Practical Experience with the EcoCell

Dr. Johann Brunthaler,

SCA Laakirchen AG;

Martin Kemper, Voith Sulzer

Stoffaufbereitung GmbH & Co. KG

In this joint article on flotation trends and developments, Martin Kemper first summarizes EcoCell technology. He emphasizes the importance of separately optimizing primary and secondary systems. The main reason is that the primary and secondary system inlet stocks differ significantly in composition and hence in rheological behaviour. The primary and secondary EcoCell concepts therefore differ accordingly.

He also explains why flotation is of growing importance in partial de-ashing. Due to its 2-stage concept, ash contents in the rejects of more than 70% are possible with the EcoCell. This enables extremely selective de-ashing. In the second part of this article, Dr. Johann

Brunthaler reports on experience with the deinking system rebuild at SCA Laakirchen AG, Austria. The object here was a 25% increase in production capacity by converting the existing E-Cell flotation system to EcoCell technology. The main requirement of this rebuild was to maintain pre-rebuild finished stock quality as regards cleanliness and yield. As shown in Fig. 6, these goals were met in full. In addition, technological results were at least as good after the rebuild despite increasing inlet stock consistency from 1.3 to 1.7%, compared with before the rebuild at the lower consistency.



Revolutionary new technology for tissue making



*The author:
Thomas T. Scherb,
Voith S.A. Máquinas e
Equipamentos, Brazil*

In the past few years, softness for tissue has become an important topic and a measure for product differentiation by many tissue manufacturers. Through air drying (TAD) can produce very soft, high-bulk sheets, however with considerable investment costs and high energy consumption. Voith Sulzer Paper Technology presents a revolutionary technology to improve softness and bulk or higher production.

Soft tissue on conventional tissue machines

Voith Sulzer Paper Technology together with Andritz, its partner from Austria for Tissue Machines, have focused their

research and development work during recent years on producing soft tissue paper, using conventional tissue machines with a Yankee Dryer.

A very important step was the use of the NipcoFlex press, the Voith Sulzer Paper Technology shoe press, successfully used for many years for other paper grades. The question of whether this press could be used for tissue production was tested on the Voith Sulzer Paper Technology pilot machine in São Paulo. The application of a NipcoFlex shoe press for Tissue production resulted in the TissueFlex Technology which ensures production of a smooth and bulky sheet or allows for higher production rates.



Fig. 1: The pilot machine.

Fig. 2: NipcoFlex roll at Yankee.

Fig. 3: TissueFlex technology for tissue.

Fig. 4: NipcoFlex roll.

Fig. 5: Comparison of the pressure profiles.

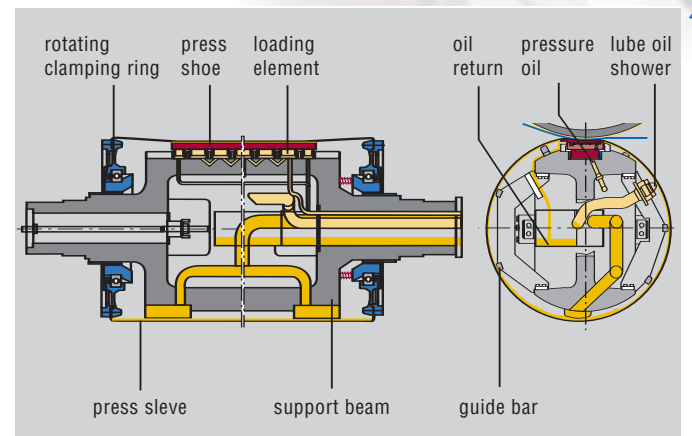
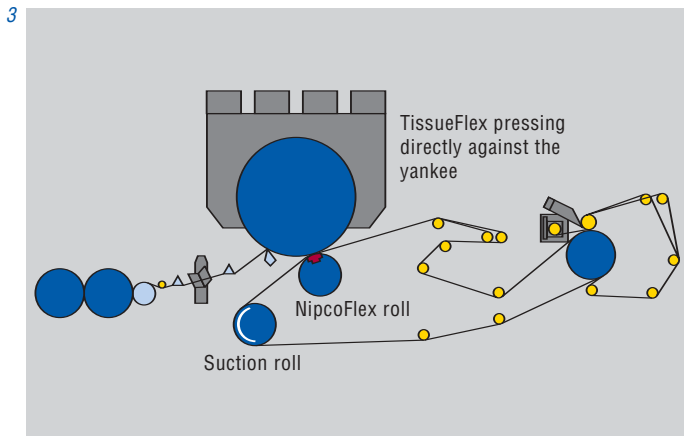

Characteristics of the pilot machine

The pilot machine can produce theoretically 30 t/day. The width is 40" (1,000 mm), the max. speed is 6,560 fpm (2,000 m/min), and the Yankee Dryer is 12 ft (3,660 mm) in diameter. The machine can be run in several configurations such as Crescent Former or with the Voith Sulzer Paper Technology gap former concept, the DuoFormer T.

The headbox can be operated with one, two or three layers. The machine is also equipped with a reel that allows the windup of jumbo rolls that can be then shipped for converting (Fig. 1).

After extensive trial work, a configuration with a NipcoFlex roll, pressing directly against the Yankee Dryer – replacing the conventional suction press roll – proved to be the best solution. This configuration is known as TissueFlex technology (Fig. 2). The water content of the felt of a

Crescent Former or a DuoFormer T must be reduced before entering the NipcoFlex roll, which is done by a suction turning roll (Fig.3).

The NipcoFlex roll is a completely enclosed shoe press system. The shoe press is supported on a rigid, stationary beam and pressed against the mating Yankee Dryer by individual loading elements, using pressurized oil. The flexible, rotating press sleeve encloses all internal roll-loading elements. The NipcoFlex roll is not driven (Fig.4). The shoe of the NipcoFlex roll is very flexible and has the additional advantage that it can follow the shape of the Dryer surface when it is deformed by the linear nip force. Therefore, there is no longer a need for machining a crown on the Yankee, which is a big advantage in maintaining a good rate of operation for the tissue machine. The creping quality is improved because the sheet is pressed uniformly against

the Yankee, keeping a good moisture profile.

The shape of the shoe influences the nip pressure curve, and the area below this curve is the linear force. In comparison with a conventional press, this type of press can generate the same linear force, at a lower maximum nip pressure (Fig. 5). From the theory we know that we are losing 10% of dryness due to rewetting in a conventional suction press roll configura-

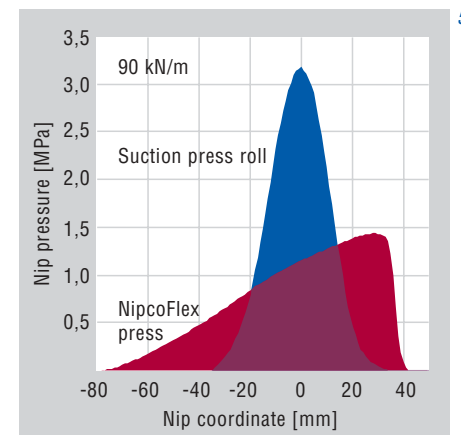

Trial results with NipcoFlex:

- NipcoFlex
- Suction press

Fig. 6: After press dryness x linear force.
 $G = 13.8 \text{ g/m}^2$, ref. 23 SR cold yankee/hood,
 flat samples.

Fig. 7: Specific volume as a function of the
 max. nip pressure. $G = 13.8 \text{ g/m}^2$, ref. 23 SR
 cold yankee/hood, flat samples.

Fig. 8: Bulk x linear force.
 Toilet, $G = 20 \text{ g/m}^2$, unrefined; creped samples.

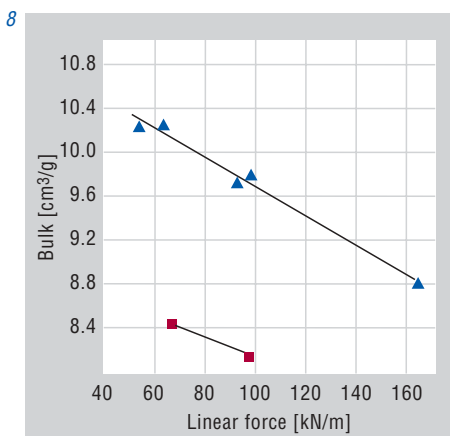
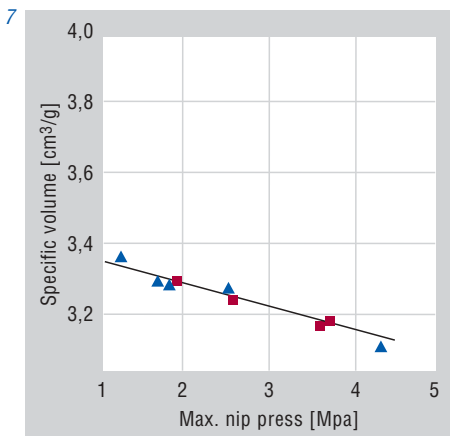
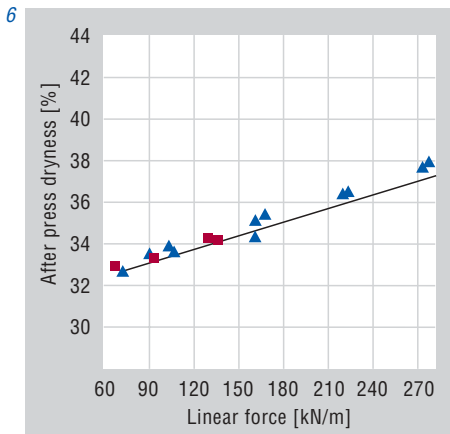

tion. With NipcoFlex, the asymmetrical nip and quick pressure drop at the outlet of the shoe, minimizes rewetting of the sheet.

The shoe can easily be changed and different shapes of shoe can produce different nip pressure curves. Thus, it is possible to optimize the shape of the shoe either for better drying or for better bulk.

Trial Results

Bulk

The trial results have shown that the after-press dryness depends upon the linear press-nip force, while the sheet bulk depends on the maximum specific nip pressure (Fig. 6 and 7). The NipcoFlex press has a maximum nip pressure 50% lower than a suction press roll at equivalent linear forces. The TissueFlex technology achieves the same dryness with 50% less maximum nip pressure, resulting in a bulkier sheet (Fig. 8).

A 15% to 30% increase in bulk was achieved in comparison to a suction press roll configuration at the same operating parameters, without a significant loss in strength. The gain in bulk results in gain of absorbency and structural softness. If we optimize coating, this gain in bulk can be used for surface softness improvement. The gain in bulk is a function of the pulp properties; the gain is greater with bulkier paper. These results can further be improved by the use of a two-layered headbox with a fixed

dividing wall between the layers. The fixed dividing wall allows different jet-to-wire ratios for each layer, which also contributes to higher bulk. The bulk achieved with the TissueFlex technology at the pilot machine in comparison to other machines is shown in Fig. 9.

As the pilot machine was not optimized, additional bulk gains can be expected. Also, the softness and the water absorbency of the sheet were excellent. The sheet characteristics of the TissueFlex sheets are close to the through-air dried (TAD) sheets.

Dryness

To achieve higher dryness, the TissueFlex technology needs higher linear nip forces than are used today (Fig. 10). A new T-shaped ribbed Yankee was developed for this purpose and is called Yankee T.

Compared to the rectangular ribs used today, a Yankee Dryer with T-shaped ribs can be subjected to higher loading and can withstand the necessary linear force of up to 200 kN/m. As there is more material on the inside of the wall, the shell has greater strength because of the I-beam principle (Fig. 11). This allows the maximum TissueFlex nip pressure to be set equal to that of a conventional suction press roll. By doing this, the sheet bulk (which is governed by the maximum nip pressure) will be main-

tained, while allowing a 3 to 5 percentage point increase in dryness. Additionally, thanks to the new shape of the ribs, this Yankee Dryer also has a larger heat transfer area, which allows a lower condensate film thickness. It therefore results in 5% more efficiency than a conventional Yankee dryer of the same diameter.

This combination of higher drying through the press nip and greater Yankee efficiency results in a production increase of up to 10 to 20%, without a reduction in bulk.

Economics

In addition to the increased bulk and/or higher production throughput benefits, the TissueFlex technology has other economic advantages versus conventional suction press roll machines. The NipcoFlex shoe press does not need a complete spare roll. Only a spare shoe is needed. The expected sleeve life is about three months on high machine speeds. Sleeve changing time is below two hours.

The investment cost for a Tissue Machine equipped with the TissueFlex Technology is only slightly higher than for a conventional tissue machine. Even with the slightly higher capital cost, the better tissue quality and/or higher productivity rates pay for the extra capital cost. The TissueFlex technology can also easily be

applied to existing machines. The existing suction press roll is reused as a suction turning roll with the same drive and is moved to a new position to allow the installation of the shoe press acting directly against the Yankee.

Future Trials

Some of the variables, which can significantly affect TissueFlex performance, include, felt design, type of pulp and the use of patterned felt. By optimizing these parameters, we should be able to more closely approach the performance of a TAD machine.

The first step will be to optimize the felt design for the TissueFlex configuration, because thus far all experiments have been run with the same felt for both the TissueFlex and suction press roll configurations. The second step will be to run special bulky fibers, such as curled fibers, because trials have shown that bulkier sheets result in even greater bulk gains through the TissueFlex process. Finally, trials will be performed with patterned felts. These felts have an imprinting effect on the sheet, which can increase bulk even further.

Summary

The TissueFlex technology allows the production of a sheet similar to a through-air dried web and is a simple, inexpensive alternative to TAD. It also allows higher production rates.

Fig. 9: Bulk development; Basis: non converted tissue paper.

Fig. 10: Comparison of the pressure profiles.

Fig. 11: T yankee design.

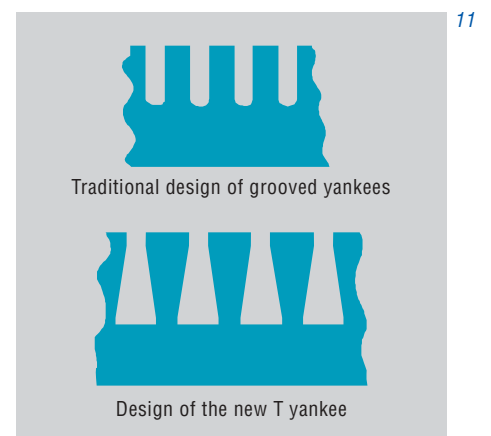
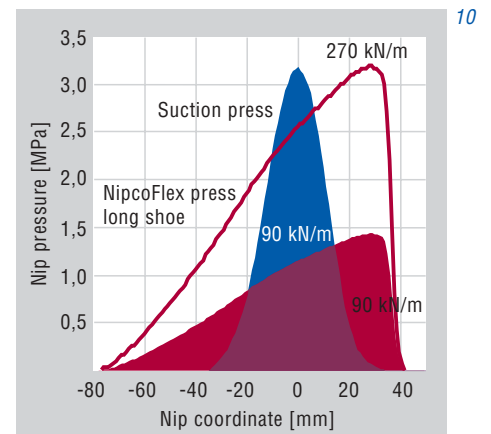
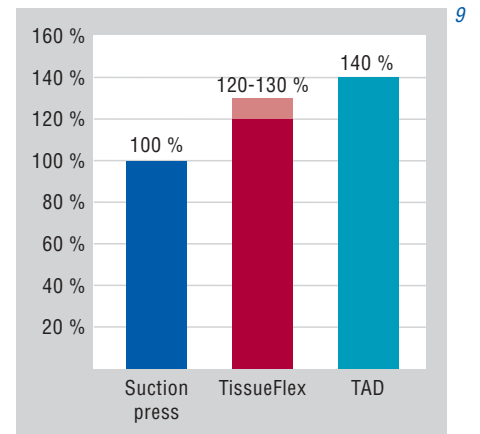

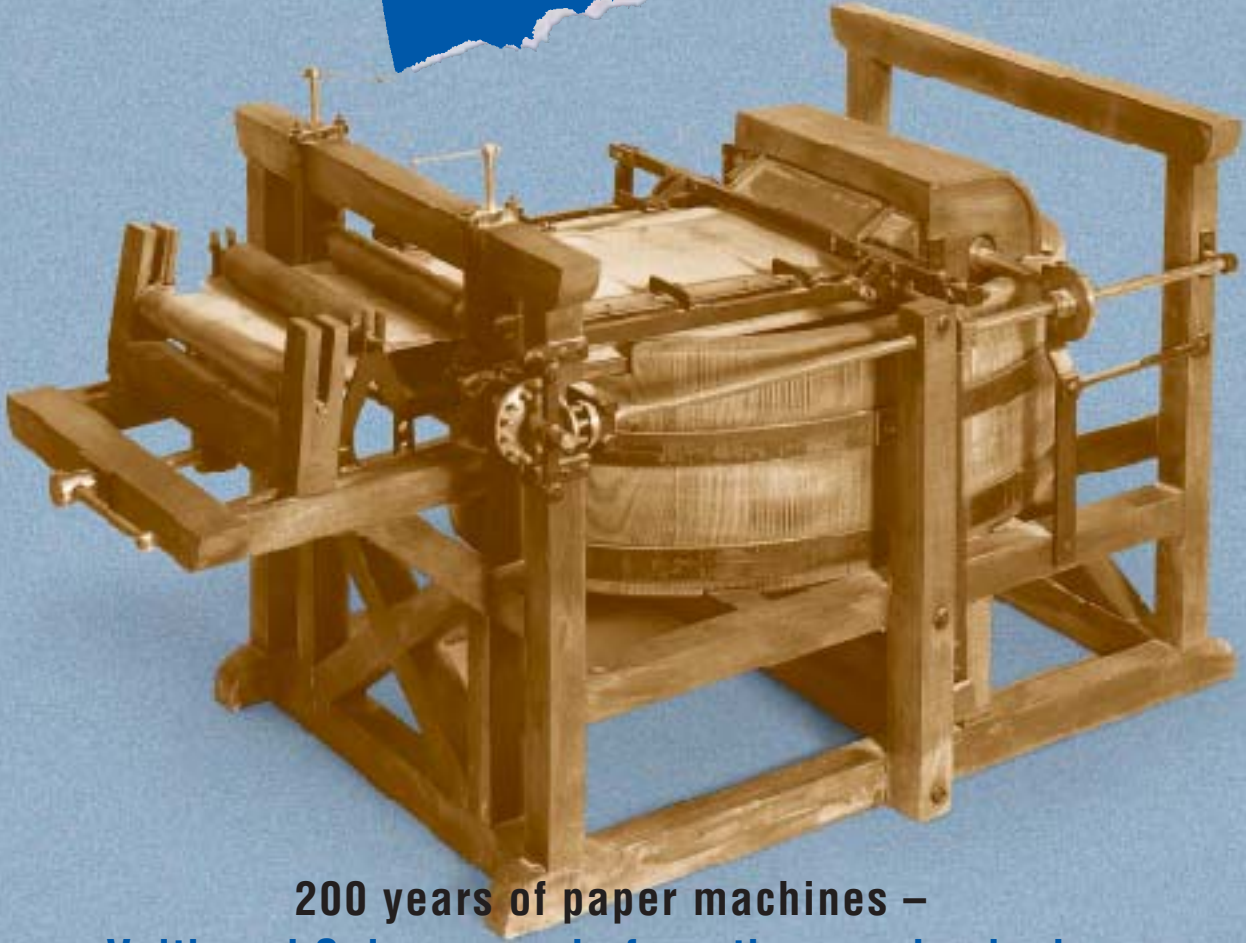

200 years of paper machines – Voith and Sulzer were in from the very beginning

It was already more than 1000 years old, the formula compiled by Tsai Lun, an official at the Chinese Emperor's court, before it reached Europe. It contained the secret of how to make paper from a pulp consisting of plant fibres, glue and various other ingredients for strength and colour, which still today forms the basis for the successful production of our most significant communication medium.

Invented in the year 105 and, like the production of china, guarded initially as a precious secret, the betrayal of which was punished with the death penalty; in due course revealed and sold, partly forgotten and adapted, the wearisome journey of the papermaking art took 600 years to reach the Middle East and another 500 years, via North Africa and Sicily, to become known in Spain and



Nicolas Louis Robert, born in Paris in 1761, invented a fully functional endless-wire paper machine in 1799. The picture is based on an embossed watermark.

Above: Model reconstruction of the first paper machine based on Robert's plans. Deutsches Museum, Munich.

Italy where, in the late 13th century, the first paper mills on the European mainland were built.

Parchment, the dominant writing material made from animal skin and originally invented in Pergamon, was gradually replaced by paper. Supported by Gutenberg's invention of movable letters and the art of printing, paper was accepted as the most satisfactory writing material and economical printing medium in the Old World and beyond. This marked the development of a most significant craft trade. Although paper formulae and quality were improved from generation to generation and several manufacturing processes were mechanised, the most laborious one, dipping the sheets with the aid of a manually shaken screen, remained unchanged.

The marketable development of Robert's invention: this machine was commissioned by the Fourdrinier brothers at the beginning of the 19th century. Deutsches Museum, Munich.

Bottom: Woodcut of the Fourdrinier paper machine in operation, with the wet and dry ends easily visible. The reeled paper is cut manually.

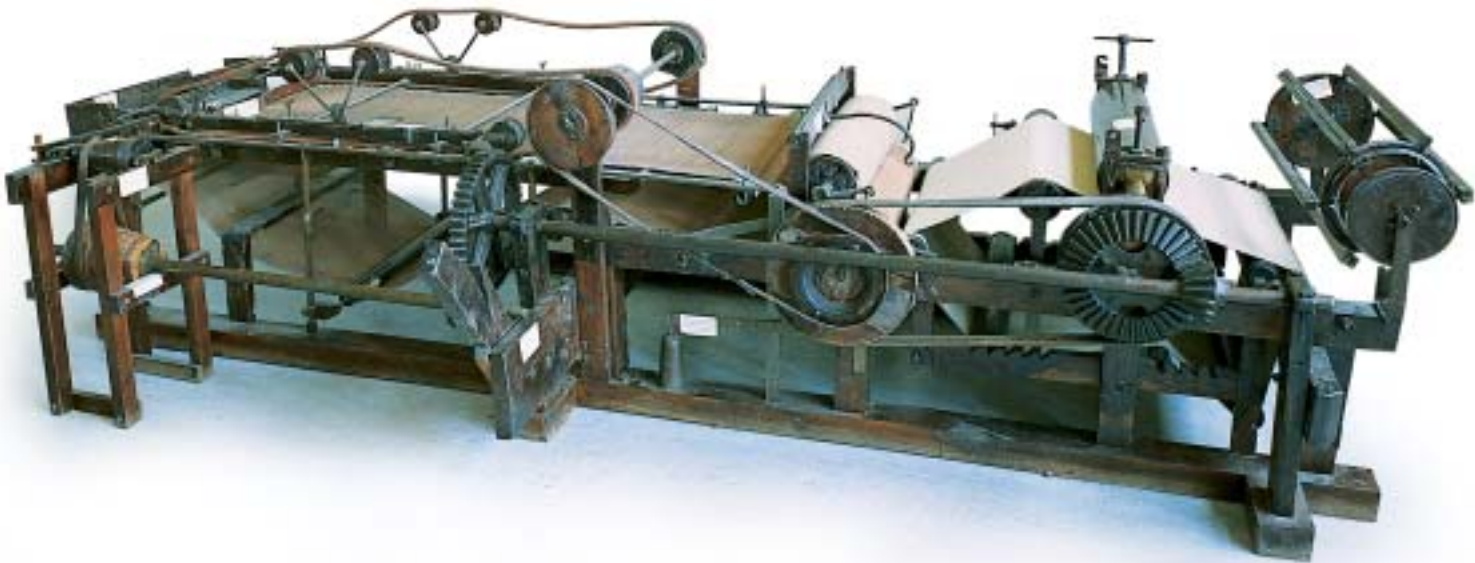

It was not until 1799 that **Nicolas Louis Robert**, a resourceful mechanic at the Didot paper mill in the French town of Esonnes, succeeded in constructing a workable “paper shaking machine”, as it was described in the patent specification. *“I have always dreamed of simplifying the process of paper sheet formation, not only to cut production costs but also to produce sheets of unusual length.”* This is how Robert explained his invention.

From the middle of the 18th century, wallpaper became increasingly fashionable. Even in the castles and palaces of the aristocracy and nobility, wallpapers steadily replaced tapestries and hides, which had become far too expensive.

The French papermaking centres and wallpaper factories were soon famous and supplied half of Europe with their products. All of them, however, encountered the same problem: inadequate lengths of paper web. For wallpaper extending from the floor to the ceiling of a room, the individually dipped sheets had to be glued together or laminated. Anyone who could

overcome this handicap would clearly be one step ahead of all his competitors in this highly popular business area.

It is likely that these and similar considerations inspired Robert's constructive ambitions. Unfortunately his financial resources were insufficient to exploit the patent himself. He therefore sold it for 25,000 French francs to Léger Didot and built on his behalf the prototype of an **endless-wire papermaking machine**.

This was vastly different in appearance from what we know today, but the fundamental principle still applies, and is as brilliant as it is simple. It consists of an endless, close-meshed wire screen, rotat-

ing around two drums mounted some distance apart. This also happened to be the first conveyor belt in the world's history! The device was located above an oval vat. By turning a crank handle, the screen could be moved lengthwise. A bucket drum continuously lifts pulp slurry from the vat on to the screen. The resultant wet paper web is wound on to a drum and periodically removed. This was the **very first continuous-action papermaking machine**.

Since then, 1799 has been considered the year in which mechanised paper production was born, which enables us in 1999 to celebrate its 200th anniversary.





But how does the story of papermaking continue after 1799 and when did the names of Voith and Sulzer appear for the first time in the annals of paper technology? At the beginning of the 19th century the machinery manufacturers in England were considered the most advanced in the world. For this reason, Léger Didot looked for contacts on the other side of the Channel, convinced the paper dealers **Henry and Saely Fourdrinier** of his new idea and granted them a third share in his patent rights. They commissioned Bryan Donkin, a competent designer and mechanical engineer, to implement and develop Robert's idea. The first machine, with a working width of 76 centimetres, was completed in 1803. Shortly after this a second machine was built with a working width of 152 cm. The Fourdrinier brothers invested their entire assets in the realisation of further and better machines. By the time they were granted their first independent patents for the **Donkin-Fourdrinier paper machine** in 1808, they had completely run out of money and had to go into receivership. Nevertheless, the principle of mechanised paper production had become so fascinating that it was picked up and steadily developed in all its details by many capable brains from the still young science of engineering. From England, this principle soon started its triumphal progress around the world.

In 1815 or thereabouts, the first German paper mills began to import this British

innovation. Due to the high Continental customs barriers only a few prosperous paper mills could afford to purchase original Donkin paper machines. But as we know, necessity is the mother of invention! The South German paper manufacturing centres in particular, between Nuremberg and Ravensburg, but also those in neighbouring Austria and Switzerland tried with the help of capable engineers to develop independent solutions, modifications and alternatives based on new concepts of mechanised process technology.

In Heidenheim, where the Swabian Alb hill region begins, **Johannes Caspar Voith** was operating a metalworking shop together with his son **Johann Matthäus**. Their mechanical skills were highly regarded by the nearby textile factories and mills when it came to the construction and repair of the water wheels, transmissions and equipment used to drive the machinery. When the Voelter paper mill burnt down in 1821 the "metalworker Voith" was commissioned to repair the machines and to adapt them as far as possible to state-of-the-art mechanised paper production. The work was completed successfully in 1824. This date and the co-operation with **Heinrich Voelter** were to become of historical significance. Even if still far removed from the construction of a complete paper machine, it marked Voith's entry into papermaking technology – 25 years after the invention of the modern papermaking machine.

Johannes Caspar Voith died in 1825. His 22-year-old son Johann Matthäus took over the firm and focused his efforts increasingly on the construction of papermaking machines. As early as 1830 the Voelter paper mill set up a completely new machine designed by Johannes Widmann but built and installed with the active participation of Johann Matthäus Voith. In 1837 another papermaking machine was supplied, this time developed by Voith himself.

With the increasing mechanisation of paper manufacturing, not only production capacities but also paper consumption rose rapidly. Paper manufacturers thus faced a new problem: Their traditional raw material, namely rags, had become scarce. Friedrich Gottlob developed groundwood pulp and tried to win the paper manufacturers over to his idea. It was Heinrich Voelter in Heidenheim in fact who realised the importance of this alternative and purchased Keller's invention in 1847. In 1848 Johann Matthäus Voith was commissioned by Heinrich Voelter to build the first wood grinder. Improvement trials were carried out jointly. 1852 was the year in which the Voith spindle wood grinder appeared, followed in 1859 by the Voith refiner to improve groundwood quality.

Since 1853 **Friedrich Voith** had been training at his parents' company. After a two-year apprenticeship and four years of study at the Stuttgart Polytechnic, he

found a job as a young engineer at the new Ravensburg branch of Escher Wyss, set up in 1859. This was the most important machinery company in Switzerland, founded in 1805 in Zurich by **Hans Caspar Escher and Salomon Wyss** as general mechanical engineers. Like Voith they came to papermaking via the use of water power and were thus able to apply their knowledge and experience of hydrodynamic technology to the new discipline of papermaking machinery. As early as in 1841 Escher Wyss delivered their first complete paper mill.

In the first century of papermaking machinery history up to 1899, **Escher Wyss** in Ravensburg (which has been owned by **Sulzer AG** since 1968) and **Voith** in Heidenheim constructed more than 100 complete paper and board production plants as well as numerous individual

machines and units, for purposes ranging from pulp preparation to paper finishing. Before the First World War both companies together led this specific area of machine construction from a quantitative point of view. They not only pioneered quantity but also quality; their inventions have undoubtedly contributed to the great importance of paper today, its quality, its manifold applications and in particular its moderate price. When Johann Matthäus Voith entered paper technology 175 years ago, a quart-size sheet of good-quality writing paper cost as much as a loaf of bread. One third of Europe's population was still illiterate and books and newspapers were luxury products that only the privileged were able to afford.

Inexpensive paper has changed the world. The invention of the papermaking

Left: Wood grinding plant with Voith spindle grinder, built for Heinrich Voelter and shown at the 1867 Paris World Exhibition.

Bottom: The first complete Escher-Wyss papermaking machine, built in 1841.

machine and its further development were the key that opened the gate to this new world. Part of this progress was the pioneering work of Voith and Sulzer. Both names live not only on paper but actually in it and in the history of the machines that make it. Nor is this only history!

One of the many wise sayings handed down from China, the country to which we owe our paper, declares: If you want an arrow to travel a long way you must draw back the bow a long way first. In this sense the experience and competence on which Voith-Sulzer paper technology of today can draw, based on their unique and historic worldwide participation in efficient, economical, energy-saving and environmentally friendly paper manufacturing plant, is still good for ongoing top performance in the future.

Manfred Schindler

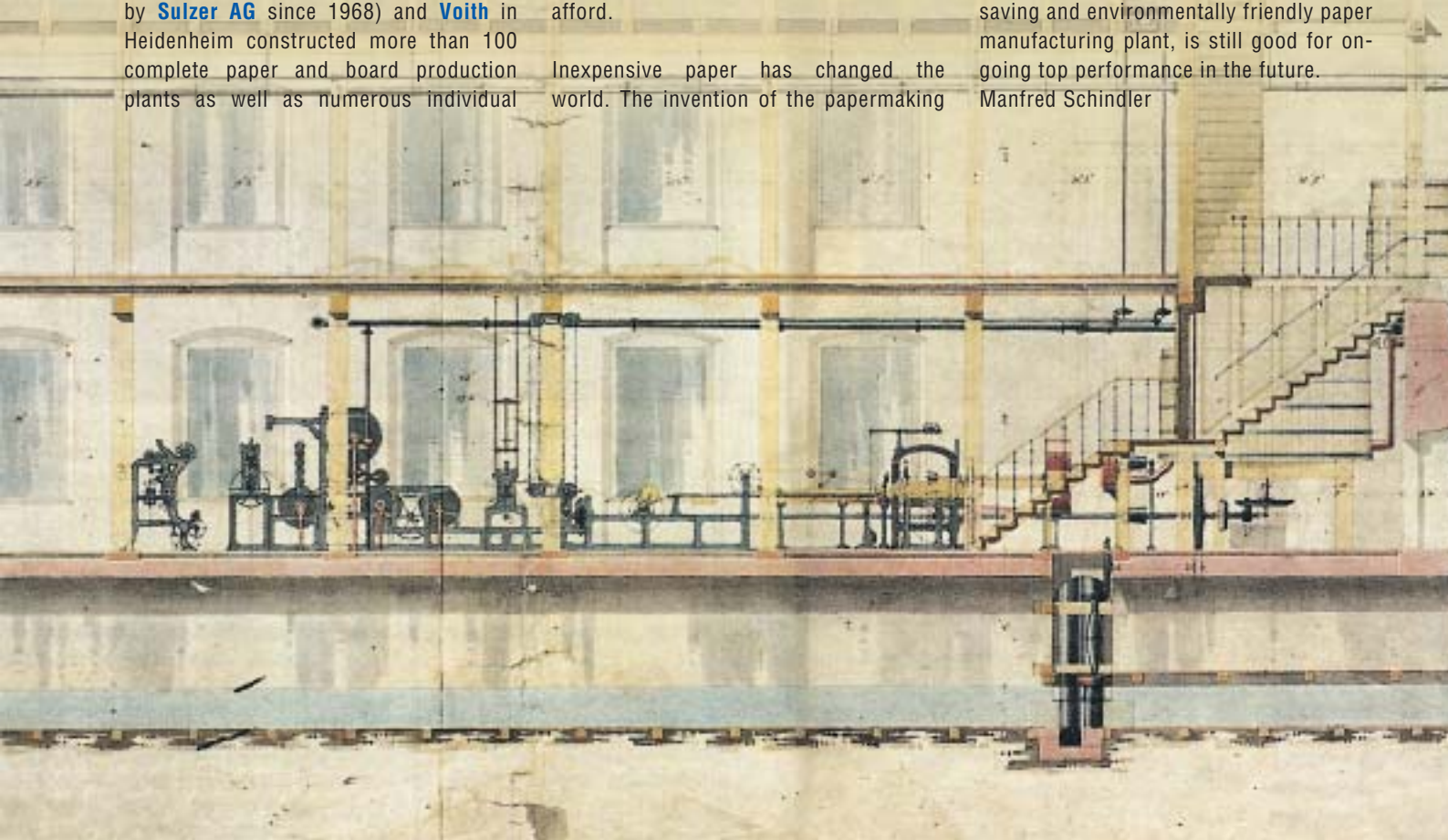

"twogether" is published twice annually in German and English. Contributions by independent authors do not necessarily reflect the opinion of the publisher. Please address all correspondence and inquiries to the editor.

*Published by:
Voith Sulzer Papiertechnik GmbH & Co. KG*

*Editor:
Dr. Wolfgang Möhle, Corporate Marketing,
Voith Sulzer Papiertechnik GmbH & Co. KG,
Tel. (+49) 73 21 37 64 05
Fax (+49) 73 21 37 70 08
P.O. Box 1970, D-89509 Heidenheim
<http://www.voithsulzer.com>*

*Editorial coordinator:
Manfred Schindler, D-73434 Aalen*

*Design, layout and typesetting:
MSW, P.O. Box 1243, D-73402 Aalen*

*Copyright 7/99:
No part of this publication may be reproduced or copied by any means whatsoever without the express permission of the editor.*

twogether

Paper Technology Journal

Newsmagazine for the international clientele, partners and friends of

VOITH SULZER
PAPER TECHNOLOGY

